



PLANNING COMMISSION STAFF REPORT

DATE: October 9, 2024
TO: Members of the Planning Commission
FROM: Greg Stones, Principal Planner
RE: Amendments to City of Lompoc Architectural Review Guidelines
TA 2024-0001

AGENDA ITEM NO. 2

Planning Commission Review and Recommendations to the City Council for proposed amendments to the City's Architectural Review Guidelines (ARGs) to provide objective design guidelines and standards for compliance with State provisions regarding eligible residential and mixed use developments in the City. This action is exempt from environmental review pursuant to Section 15061 (b)3 (Review for Exemption) of the California Environmental Quality Act (CEQA) Guidelines.

Scope of Review

The Planning Commission is being asked to consider that:

- The proposed amendments are internally consistent with all other provisions of the General Plan;
- The proposed amendments are internally consistent with any applicable specific plan;
- The proposed amendments serve the public necessity, convenience and general welfare;
- The proposed amendments are compliant with State Housing Laws; and
- The proposed amendment is in compliance with the provisions of the California Environmental Quality Act (CEQA).

Staff Recommendation

1. Adopt Resolution No. 1012 (24), Attachment 1, recommending that the City Council approve amendments to the City of Lompoc ARGs; or
2. Provide other direction.

Background

The City originally adopted the ARGs on September 19, 1995 (Attachment 2). Since the original update, several amendments have been completed (2001, 2019, and 2021). The intent of creating and implementing these guidelines was to guide development in the interest of the public's health, safety and general welfare. In addition, as stated in the guidelines, *"the goal of architectural review is development that not only is well designed, but also "fits" in the City of Lompoc, with projects that strike a balance between the developer's preference and the public interest."*

The State of California is requiring municipalities to streamline residential projects and to provide *"objective design standards."* California Government Code Section 66300(a)(7)) defines objective design standard as: *"a design standard that involves no personal or subjective judgment by a public official and is uniformly verifiable by reference to an external and uniform benchmark or criterion available and knowable by both the development applicant or proponent and the public official before submittal of an application."* California State bills that initiated this requirement include Senate Bill 35 (SB35, "Affordable Housing Streamlined Approval Process"), Senate Bill 330 (SB 330, "Housing Crisis Act"), and Assembly Bill 2011 (AB 2011, "The Housing and High Roads Job Act").

Furthermore, the development of residential and mixed-use projects in the City of Lompoc that comply with State requirements are eligible for streamlined ministerial review (i.e. building permit instead of Planning Commission review) if the project also adheres to the City of Lompoc Objective Design Standards. The standards found in the amended Architectural Review Guidelines are in addition to any existing objective Municipal Zoning Code, Building Codes, Fire Codes or other requirements/standards. For projects ineligible for SB35, SB330, or AB2011, the City Zoning Code, ARGs, and/or Specific Plan standards would apply for residential projects.

Senate Bill 2 Funding

The proposed amendments are also associated with previous funding that the City received as part of the SB2 Planning Grants Program approved on July 22, 2020 (with an extension granted until December 31, 2024). With this grant, staff committed to amending the ARG procedures and streamlining the review of residential projects with the intent and priority to accelerate housing production. As proposed, these amendments meet the requirements of the grant and following approval of the proposed amendments by the Council, the Department of Housing and Community Development (HCD) would be provided a copy of the updated ARGs to satisfy the City's grant responsibilities (no further review or commenting is required by HCD).

Proposal & Staff Analysis

In order to comply with State Housing Laws and the City's SB 2 Grant, Planning staff is proposing amendments to the City's ARGs to ensure housing projects that are eligible for streamlined review (in accordance with State housing law requirements) would be reviewed appropriately with objective design standards. In addition, staff has proposed amendments that will make the document more user-friendly and correct text within the document that is no longer applicable based on the most recent Zoning Code Updates.

In short, the following is a summary of the proposed amendments:

- Removing vague and subjective language pertaining to design;
- Adding "objective design standards" for residential projects;
- Removing the signs section for the Old Town;
- Removing references and code sections that no longer apply;
- Adding and deleting definitions;
- Adding/deleting graphics

With the proposed changes, the ARGs will meet State requirements for residential projects that qualify for a streamlined review while also providing necessary clarifications and text that is up-to-date and providing guidelines that will be easier for staff, developers, and the public to more effectively implement.

Conformance with 2030 General Plan

The various amendments are consistent with the 2030 General Plan and support various General Plan goals, policies, and measures including those pertaining to the Urban Design Element which include:

Policy 1.2: The City shall seek to protect ridgelines and hillsides which lie in view corridors, including those ridgelines identified on the Scenic Ridgelines and Roads Map (Figure UD-2).

Goal 2: Protect and enhance the "small town" character of the Old Town.

Policy 2.1: The City shall support, maintain, and enhance the historical character, scale, and architecture of the Old Town area.

Policy 2.5: The City shall encourage existing commercial facilities to improve their appearance and condition and ensure that all new development contributes toward an overall positive and cohesive visual identity.

Goal 3: Protect and enhance the positive identity of Lompoc's residential neighborhoods.

Measure 6: The City shall periodically review and update the architectural, landscape, and site plan review guidelines. [Policies 1.3, 2.1, 2.2, 3.1, 3.2, 5.1 and 5.2]

Therefore, the amendments appropriately conform to 2030 General Plan and the existing goals, policies, and implementation programs as described above.

Conformance with Zoning Code

Pursuant to LMC 17.512 (Architectural Design and Site Development Review) the ARGs apply to the review and approval of projects that require said review (ministerial and discretionary projects). In the event there is a conflict with the standards in the ARGs and the Zoning Code, the ARGs would take precedence. The proposed amendments conform with Title 17 (Zoning) and would not create any conflicts with Zoning consistency.

Environmental Determination

This action is exempt from environmental review pursuant to Section 15061 (b)3 also known as the "General Rule" Exemption of the California Environmental Quality Act (CEQA) Guidelines because the proposed activities can be seen with certainty to have no possibility of causing a significant effect on the environment.

Noticing

On September 25, 2024, a public hearing notice was published in the Lompoc Record. In addition, on October 4, 2024, the staff report and supporting materials were posted to the City's Planning Division website.

Appeal Rights

Pursuant to LMC 17.612.020(A)(2), "recommendations of the Commission which are required to be forwarded to the Council for its consideration as part of the normal review process are not appealable."

Attachments

1. Planning Commission Resolution No. 1012 (24)
2. Existing Architectural Review Guidelines

Respectfully submitted,



Brian Halvorson, AICP
Planning Manager

APPROVED FOR SUBMITTAL TO THE PLANNING COMMISSION:

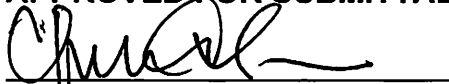

Christie Alarcon
Community Development Director

RESOLUTION NO. 1012 (24)

A RESOLUTION OF THE PLANNING COMMISSION REVIEW AND RECOMMENDATIONS TO THE CITY COUNCIL FOR PROPOSED AMENDMENTS (TA 2024-0001) TO THE CITY'S ARCHITECTURAL REVIEW GUIDELINES TO PROVIDE OBJECTIVE DESIGN GUIDELINES AND STANDARDS FOR COMPLIANCE WITH STATE PROVISIONS REGARDING ELIGIBLE RESIDENTIAL AND MIXED USE DEVELOPMENTS IN THE CITY. THIS ACTION IS EXEMPT FROM ENVIRONMENTAL REVIEW PURSUANT TO SECTION 15061 (B)3 (REVIEW FOR EXEMPTION) OF THE CALIFORNIA ENVIRONMENTAL QUALITY ACT (CEQA) GUIDELINES.

WHEREAS, the City initiated, for Planning Commission consideration, amendments to the City of Lompoc Architectural Review Guidelines to streamline project review for eligible residential projects and to comply with the City's SB2 grant requirements; and

WHEREAS, the amendments to the City of Lompoc Architectural Review Guidelines will comply with the 2030 General Plan and Title 12 (Zoning) of the Lompoc Municipal Code; and

WHEREAS, the matter was considered by the Planning Commission at a duly-noticed public meeting on October 9, 2024; and

WHEREAS, at the meeting of October 9, 2024, staff was present and answered Planning Commissioner questions and addressed their concerns; and

WHEREAS, at the meeting of October 9, 2024, _____ spoke in favor of the project, and _____ spoke in opposition to the project.

NOW, THEREFORE, THE LOMPOC PLANNING COMMISSION RESOLVES AS FOLLOWS:

SECTION 1: After hearing testimony, considering the evidence presented, and due deliberation of the matters presented, the Planning Commission finds that:

- A. The proposed amendment is internally consistent with all other provisions of the General Plan;
- B. The proposed amendment is internally consistent with any applicable specific plan;

- C. The proposed amendment serves the public necessity, convenience and general welfare;
- D. The proposed amendments are compliant with State Housing Laws; and
- E. The proposed amendment is in compliance with the provisions of the California Environmental Quality Act (CEQA).

SECTION 2: This action is exempt from environmental review pursuant to Section 15061 (b)3 (Review for Exemption) of the California Environmental Quality Act (CEQA) Guidelines. Furthermore, none of the exceptions to Categorical Exemptions set forth in the CEQA Guidelines, section 15300.2 applies to this project. Therefore, no environmental assessment is required or necessary.

SECTION 3: Based upon the foregoing, the Planning Commission recommends that the City Council approve and adopt the amendments set forth in Exhibit “A” hereto.

The foregoing Resolution was adopted, on motion by Commissioner _____, seconded by Commissioner _____, at the Planning Commission meeting of October 9, 2024, by the following vote:

AYES:

NOES:

Brian Halvorson, AICP, Secretary

Acting Chair

Attachment:

Exhibit A – Amended Architectural Review Guidelines

ARCHITECTURAL REVIEW GUIDELINES

CITY OF LOMPOC



Adopted September 19, 1995
Ordinance No. 1405 (95)

Amended June 5, 2001
Ordinance No. 1462 (01)

Amended December 17, 2019
Ordinance No. 1670 (19)

Amended March 2, 2021
Ordinance No. 1679 (21)

Prepared by:
City of Lompoc 1995 Planning Commission

Janice Keller, Chair
Kendra Beck, Commissioner
Marion "Butch" Browder, Commissioner
Ralph Harman, Commissioner
Suzie Hearrell, Commissioner

Revised by:
City of Lompoc 2001 Planning Commission

Jack Rodenhi, Chair
Ronald Fink, Commissioner
Ralph Harman, Commissioner
Ann W. Ruhge, Commissioner
Peter "Ed" Shoemaker, Commissioner

Revised by:
City of Lompoc 2019 Planning Commission

Nicholas Gonzales, Chair
Federico Cioni, Commissioner
Steve Bridge, Commissioner
Sasha Keller, Commissioner
Ken Ostini, Commissioner

Revised by:
City of Lompoc 2021 Planning Commission

Federico Cioni, Chair
Steve Bridge, Commissioner
Sasha Keller, Commissioner
Ken Ostini, Commissioner

I.	OVERVIEW	5
	A. Why These Guidelines?	5
	B. Who Does the Reviewing and What is Reviewed?.....	5
	a. Minor Architectural Design and Site Development Review.....	7
	b. Major Architectural Design and Site Development Review.....	7
II.	ENFORCEMENT	7
III.	OBJECTIVE DESIGN GUIDELINES.....	8
	A. Residential and Mixed Use	8
IV.	ARCHITECTURAL CHARACTER/BUILDING & SITE DESIGN	12
	A. Neighborhood Compatibilities.....	12
	B. Residential – Infill	16
	C. Exterior Colors	18
	D. Materials	19
	E. Lighting.....	19
	1. Exterior Lighting-Residential	20
	2. Exterior Lighting-Commercial Industrial	20
	F. Accessory Equipment	21
	3. Refuse collection areas shall be located or screened to minimize public view.....	22
	G. Awnings	23
	H. Landscaping and Open Space	23
	1. Trees and Vegetation	23
	2. Plazas and Courtyard	24
	3. Open Space-Multi-Family	24
	I. Parking.....	24
	J. Fences and Walls	25
	K. Commercial	26
	L. Industrial.....	26
V.	ADDITIONAL GUIDELINES FOR SPECIFIC ZONES.....	26
	A. Public Facility	27
	B. Mixed Use	27
VI.	ADDITIONAL GUIDELINES FOR SPECIAL DISTRICTS AND SITES	27
	A. Old Town	27
	1. Purpose.....	27
	2. Organization	28
	3. Interpretation	29
	4. Applicability	29
	5. Exemptions.....	29

6. Context & Compatibility	30
7. Design Criteria	32
a. Infill	32
b. Storefront Design	36
8. Landscaping & Public Spaces	39
a. Introduction	39
b. General Landscape Design Guidelines	39
c. Public Spaces	41
9. Designing for Crime Prevention	43
a. Design Considerations	43
10. Secretary of the Interior’s Standards for Rehabilitation	46
B. Airport	46
VII. DEFINITIONS	47
VIII. REFERENCES	49
IX. ORDINANCE	50

I. OVERVIEW

Architectural review is one of several procedures the City uses to guide development in the interest of the public's health, safety and general welfare. It was created by local ordinance to be separate from, and in addition to, other approvals (such as Architectural Design & Site Development Review, a Conditional Use permit, rezoning or a building permit) which might be required for a project. Although architectural review of some projects is done by the Planning Commission, City Planning staff handles architectural review for the majority of projects within the City.

Architectural review is a process to review development before something is built or modified. The process may look at more than building design. It also examines a project's layout with its relationship to the neighborhood as well as the effect the development will have on the overall quality of life in Lompoc, and all factors in a project's appearance. Some of these factors may be considered separately by the City's Planning Commission as part of a discretionary permit, for example, but they must also be considered as part of a complete architectural project proposal.

The purpose of this book is to provide design guidelines/standards for architectural review for projects based on recognized principles of design, planning, and aesthetics. These guidelines are for discretionary projects (i.e. CUP, DR) and ministerial projects (i.e. building permits), and apply to all types of development in the city. Section III is specific for residential projects meeting State provisions (discussed more below) but can be applied to all residential projects (new units) as well.

The City encourages creative design, new ideas in the use of building materials, and innovative construction methods, as long as what is proposed falls within the City's guidelines. Yet, while encouraging creativity, the City also tries to be sure there is worthwhile purpose behind innovation. The goal of architectural review is development that not only is well designed, but also "fits" in Lompoc, with projects that strike a balance between the developer's preference and the public interest.

A. Why These Guidelines?

Applying the City's principles to complex construction projects can be a long process. That is why the City prepared these guidelines: to explain why the City requires architectural review, what are the benefits, how it works, and to provide clearer standards which will improve and quicken the architectural review process.

B. Who Does the Reviewing and What is Reviewed?

1. Architectural Design and Site Development Review (discretionary permit) shall be required for all new buildings or structures and additions and alterations to existing structures with the following exceptions:

- a. Single-family homes in R-1 zones, and development projects with six (6) or fewer residential units in the R-2, R-3, and MU zones, that are not part of a subdivision map.
- b. Accessory dwelling units;
- c. Additions of floor area within the existing building envelope;
- d. Additions and alterations to existing buildings and structures that will not increase the gross floor area of the building by more than 2,500 square feet and will not involve exterior alterations along any street-facing façade on Ocean Avenue, H Street (north of Cypress Avenue), or Central Avenue; and
- e. Alterations and improvements required to meet Federal or State requirements to accommodate persons with disabilities.
- f. Residential Projects Meeting State Provisions: In accordance with California Government Code Sections 65400, 65582.1, and 65913.4 (Senate Bill 35 – “Affordable Housing Streamlined Approval Process”), Government Code Sections 65589.5, 65940, 65943, 65950, 65905.5, 65913.10, 65941.1 and 66300 (Senate Bill 330 - “Housing Crisis Act”), and Government Code Sections 65400, 65585, and 65912.100 (Assembly Bill 2011 - “The Housing and High Roads Job Act”), the development of residential and mixed-use projects in the City of Lompoc that comply with the above cited State Code sections are eligible for streamlined ministerial review (i.e. Building permit) if the project adheres to the City of Lompoc objective design standards and Zoning Code. In addition, residential developments with 20% of the units are affordable to lower-income households that are on a vacant or nonvacant parcel used in the City’s previous two Housing Elements sites inventory to accommodate lower income units are also eligible.

Government Code Section 66300(a)(7)) (Senate Bill 330) – defines objective design standard as: “a design standard that involves no personal or subjective judgment by a public official and is uniformly verifiable by reference to an external and uniform benchmark or criterion available and knowable by both the development applicant or proponent and the public official before submittal of an application.”

These standards (found in section III.A) are in addition to any existing objective Municipal Code requirements (zoning development standards), Building Codes, Fire Codes or standards adopted prior to SB35 (i.e. Specific Plan). For projects ineligible for SB35 / SB330 / AB2011, the City Zoning Code, Architectural Design

Guidelines, and/or Specific Plan standards will apply (see below section I.B.2.).

If there is a conflict between the objective design standards provided in the Architectural Review Guidelines and the Zoning Code then the objective design standards control for projects that comply with above cited state code sections and are eligible for streamlined ministerial review.

2. An application for an Architectural Design and Site Development Review shall be prepared, filed, and processed in compliance with Chapter 17.512. The Review Authority for an Architectural Design and Site Development Review shall be as follows:

- a. **Minor Architectural Design and Site Development Review.**

All projects that do not meet the criteria for Commission review as specified below and are not exempt (17.512.020) shall be subject to review and approval or denial by the Director.

- b. **Major Architectural Design and Site Development Review.**

The Commission shall be the Review Authority for any of the following:

- i. New construction of more than 2,500 square feet of gross floor area or new additions of more than 2,500 square feet of gross floor area; or
 - ii. New construction with frontage on Ocean Avenue, H Street North of Cypress Avenue, or Central Avenue (excluding additions); or
 - iii. Any major façade improvements with frontage on Ocean Avenue, H Street (north of Cypress Avenue), or Central Avenue. (Ord No. 1679 (21)).

II. ENFORCEMENT

All requirements of these Architectural Review Guidelines shall be enforced by City staff. Enforcement shall be carried out in the manner prescribed by State law and Lompoc Municipal Code Chapter 17.624 (Enforcement).

III. Objective Design Guidelines

A. Residential and Mixed Use

This section applies to construction of residential and mixed use projects in the R1, R2, R3, RA, MU, PCD/HSO, OTC zoning districts including projects that are eligible for streamlined review per the state code section mentioned in section I.B.f. Residential projects seeking exceptions / modifications from development standards including these objective design standards are not eligible for ministerial/streamlined processing and may be subject to discretionary review in accordance with Zoning Code 17.512 (or other applicable code sections), except modifications requested and allowed under density bonus law.

1. Building entries shall be protected from the elements and create a focal point for the structure. This can be achieved by incorporating the following:
 - a. Providing a roof or change in roof pitch or form (i.e. gable) that extends a minimum of 18 inches past the entrance.
 - b. Provide wood, stone, tile, or brick accent features covering a minimum of 20 percent of the entryway wall surface area.
2. Architectural features shall be used to enhance building elevations and break up unacceptable bulk (i.e. flat blank walls) by using at least 5 of the following methods:
 - a. Rooflines (the frontage below the roof and the eaves including the fascia, soffits, box end/bargeboards).
 - b. Using combinations of vertical and horizontal elements, via variations, projections, or reveals in wall plane.
 - c. Creating patterns with doors and windows (i.e. style types, number of panes/panels, amount of exposed glass).
 - d. Using recessed and projecting spaces of at least 6" to create interest.
 - e. Stepping above level floors back by 2 feet for every 20 feet of wall facing the street and/or front facing elevation.
 - f. Provide architectural elements on the building which occupy at least 25% of the building face.
 - g. Provide at least 2 inch thick wainscot (wood or stone) at least 3 feet tall from ground level on the first floor and incorporate at least a 2 inches to 3 inches molding on the edges.

- h. Provide at least a 1 inch width trim around the windows and doors or 2 inches window recess depth
- i. Provide at least a 6 inch cornice around the building.
- j. Provide at least 4 inch columns on the building face or entrances.

Picture Example: Single-Family and Multi-Family with Architectural Features



- 3. Garages shall incorporate the following:
 - a. Garage doors shall not face a street(s) but may be oriented toward an alley or a private driveway or shall be setback 2 feet from the wall plane of the residence facing the street.

- b. Garage doors shall be recessed a minimum of six (6) inches from the surrounding building wall and shall include trim of at least 1.5 inches in depth.

Picture Example: Houses with Architectural Features and offset garage with Trim



4. For new residential developments (with 7 or more units) a minimum of five different street frontage designs, not including mirror images, shall be provided. A particular street frontage design, including its mirror image, should not appear more often than every fourth house / structure.
5. Open Space in Multi-Family developments - In multi-family residential units, both private and common usable open space shall be provided in compliance with Zoning Code Table 17.208.040.A (Residential Zones Development Standards - Landscape Open Area) or section 17.404.150 (Mixed-Use Development). Private usable open space for each dwelling unit shall be directly accessible from the unit (this can include decks/balconies, patio areas, gardens, etc.) to permit outdoor living opportunities. Common areas should be readily accessible from all buildings.
6. Views and Obstructions- Obstruction of views should be minimized through reduction in the height of the structure, location of the higher portion of the structure so as to minimize the adverse impact, and the avoidance of tall landscaping. Hillside development in areas with a slope greater than 20% shall incorporate the following:
 - a. Placing a proposed two-story residential structure in a location as to not block more than 50% of the existing view as seen from the existing adjoining residential lots front or rear yard (ground level).
 - b. Preserve surrounding ridge-tops by placing buildings in a location so that the tops of two-story structures in hillside development are below the skyline as seen from the nearest arterial or collector street.
 - c. Placing trees in a location that do not block more than 50% of the existing views (as seen from ground level).
7. Colors and Materials - Exterior changes in color and/or materials shall occur at changes in plane and at inside corners or architectural features that break up the wall plane (i.e. wainscot, cornice, column, pilaster, banding, balcony). Colors may be varied. The colors of all elements of a development including walls, accessory structures, fences, bollards, and signs should be compatible with each other and with materials, architectural style, and details. Accent colors that are complementary to the primary color may be used. A color plan showing the location of all colors on the building and color chips of colors (specifying model and manufacturer names/numbers) shall be submitted to the Planning Division for review and approval.

8. For mixed use projects, the commercial component shall be facing the street(s) with at least 50% of the ground floor building wall to be transparent (windows). Residential uses shall be located on the above floors and/or located on the first floor if the residential use does not face the street. For buildings with H Street or Ocean Avenue frontage in the OTC Zone, residential uses may only be located on the first floor if the residential use does not face the street (i.e., H Street or Ocean Avenue) and residential access is provided at the rear of the building.
9. For residential / mixed use projects in the OTC zone, the architectural design guidelines provided in the OTC section in these guidelines also apply.
10. Pedestrian walkways shall connect building entrances to areas throughout the site including parking areas, common open space, waste areas, public sidewalks, amenities.

IV. ARCHITECTURAL CHARACTER/BUILDING & SITE DESIGN

A. Neighborhood Compatibilities

A neighborhood is primarily defined as that area of the City that is visually impacted by the proposed building project. This normally will include the street frontage between adjacent cross streets, properties along that frontage, and properties located within the same block as the building project.

1. Each phase of a phased development shall complete construction (i.e. complete work on the building, and any common areas such as roads, and sidewalks). Temporary barriers/walls should be painted and trimmed to integrate with the permanent construction.
2. Housing types may be mixed within each new subdivision (i.e., duplexes and townhouses can easily and effectively exist in the same neighborhood as single-family homes).
3. All proposed buildings or structures should be sensitive to the neighborhood character (i.e. the general shape of the building, materials, craftsmanship, decorative details, and features) with other properties located within the area (neighborhood blocks) of the subject project.
4. Design elements should be used that are consistent with the existing style.
5. The construction of multi-story buildings or additions in predominantly single-story neighborhoods can be compatible provided the design incorporates features, which enhances or reduces the noticeability of the second floor. Include at least one of the below design features:

- a. Avoidance of continuous horizontal trim between floors;
- b. Provision of second floor offsets (at least 6 inches) to avoid an unrelieved two-story wall;
- c. Placing the second floor towards the back of the building to avoid a two-story profile at the street; and
- d. Placing the second floor in the middle of the footprint to provide a one-story transition to adjacent buildings.

Picture Example: Wall plane variation

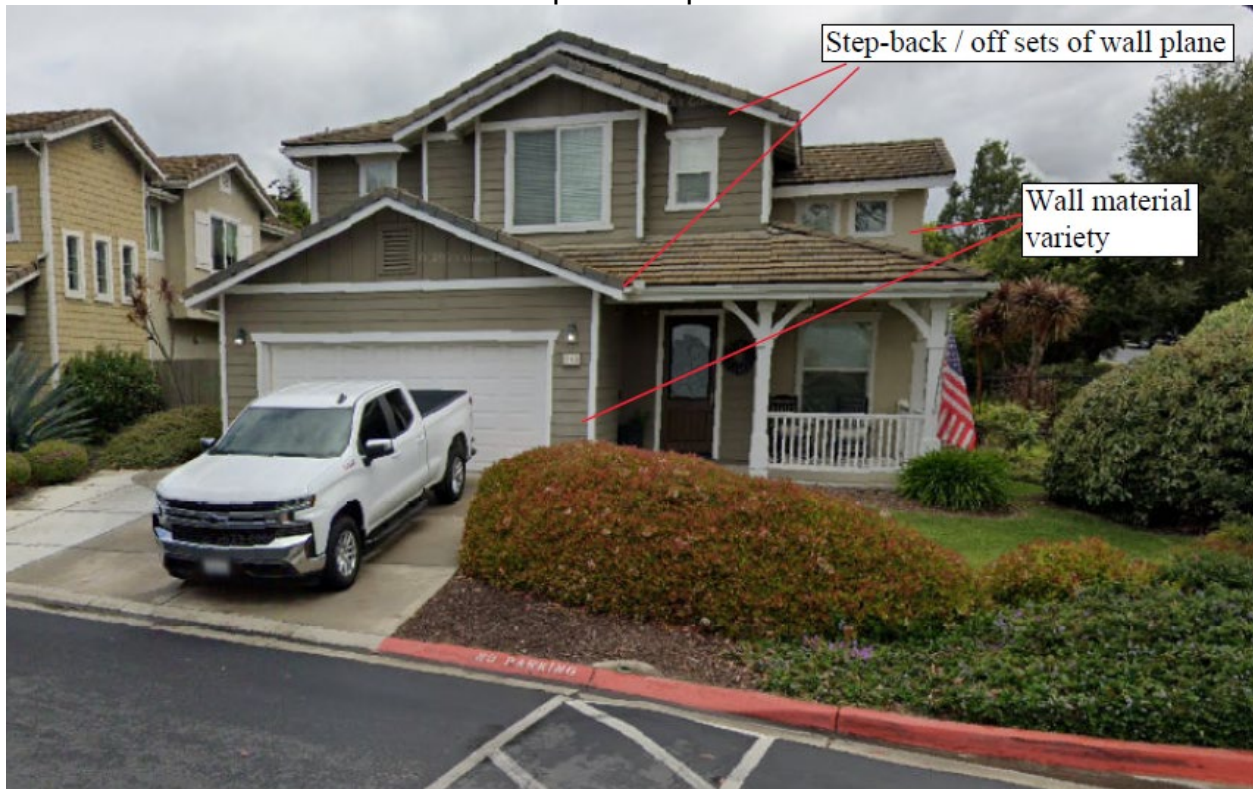

Picture Example: Wall plane variation

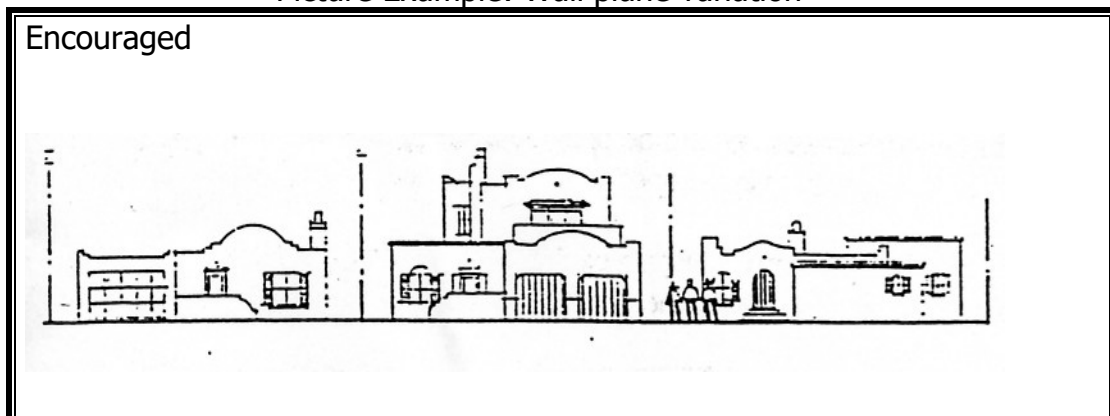

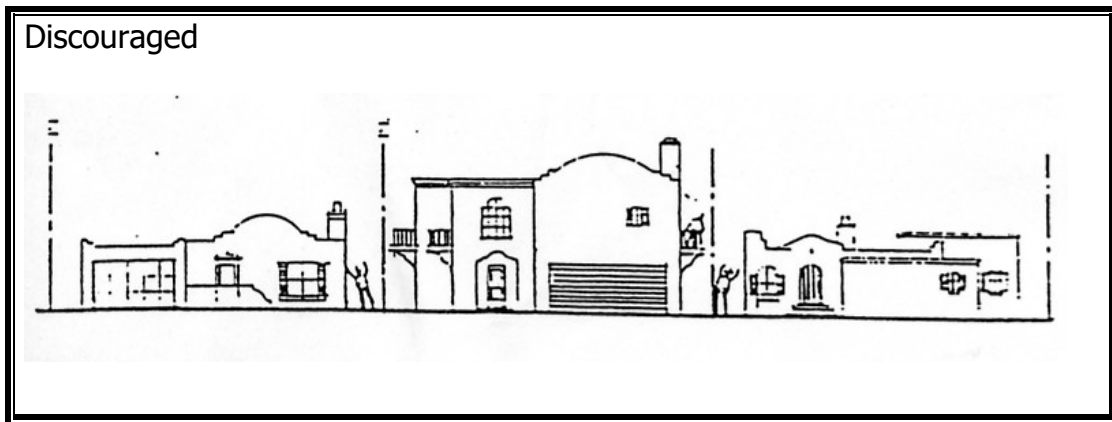

6. Multiple buildings on the same site shall be designed with similar and compatible architectural style with subtle variety in building size and mass.
7. Buildings shall incorporate architectural building elements such as wall insets, balconies and window projections, etc, which help reduce the scale of larger buildings.
8. All buildings elevations visible to the public shall be designed and architecturally treated. The choice of materials, colors, and the level of detailing shall be integrated into the design. All elevations need not look alike; however, a sense of overall architectural continuity is encouraged.
9. Parapet walls and screen walls shall be integrated with the architecture.
10. Building entries shall be protected from the elements and create a focal point for the structure. This can be achieved by incorporating the following:
 - a. Providing a roof or change in roof pitch or form (i.e. gable) that extends a minimum of 18 inches past the entrance
 - b. Provide wood, stone, tile, or brick accent features covering a minimum of 20 percent of the entryway wall surface area
11. Rooftop mechanical equipment is not prohibited, but its design and screening must be incorporated in the building design so as not to appear cluttered in compliance with Zoning Code section 17.312.040.G. This can be accomplished by providing a parapet or other architectural element to screen the equipment.

Picture Example: Screening equipment on the roof

Incorporating design elements and parapet to screen roof mechanical equipment



12. The ground floor levels of buildings where pedestrian activity is high shall include architectural elements to pedestrians such as providing display windows, views into retail shops / restaurants, architectural façade elements and courtyard entrances.

Picture Example: Comparing wall planes with features / windows vs. blank wall

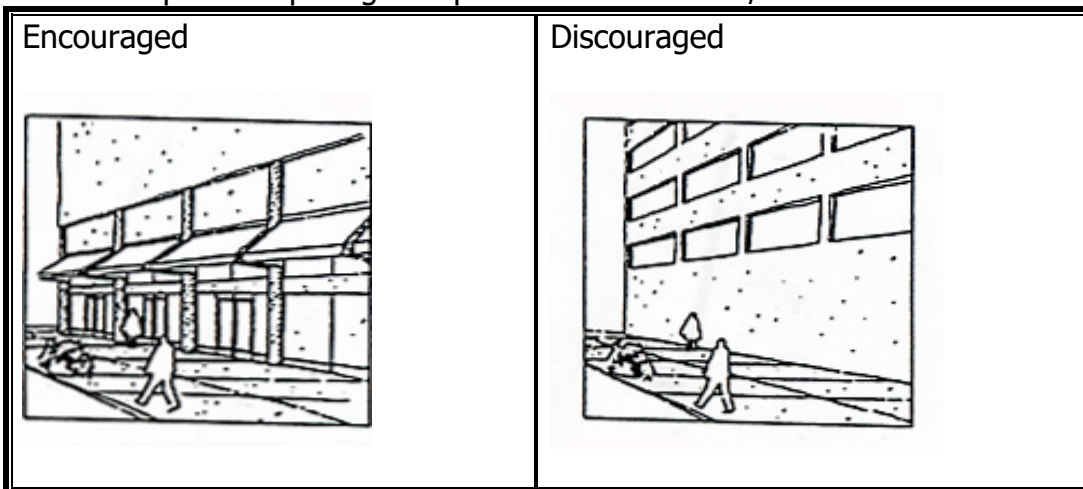

13. Uses which visually disrupt the continuity of pedestrian movement (such as open parking lots, parking structures, backs of buildings, or delivery areas of buildings) should be designed to “bridge” the active areas.

14. Large paved areas should be avoided. Paved areas should be broken up by using colored materials and/or landscaping.
15. A unified theme should be incorporated into each commercial center. Additions and alterations must be consistent with and enhance the design theme.

B. Residential – Infill

This section applies to additions, remodels and ADU's/JADU's in residential zones (R1, R2, R3, RA, MU, OTC).

Pursuant to Government Code section 66314, subdivision (b)(1), only objective standards can be applied to Accessory Dwelling Units (ADU's) or Junior Accessory Dwelling Units (JADU'S) that include, but are not limited to, parking, height, setback, landscape, architectural review, maximum size of a unit, and standards that prevent adverse impacts on any real property that is listed in the California Register of Historical Resources. Additional requirements and objective development standards for ADU's/JADU's can be found in Zoning Code section 17.404.202.E & F.

1. Architectural style shall be compatible with the existing residence.
2. Architectural features shall be used to break up boxy structures and/or flat walls, such as incorporating varying rooflines, using combinations of vertical and horizontal elements, creating patterns with doors and windows, providing trim around doors and windows, using wainscot/banding, or using recessed and/or projecting spaces to create interest.

Picture Example: Home with varying rooflines, trim, architectural features to break up wall plane



3. Exterior Colors and Materials shall be compatible with the existing home and neighborhood based on the surrounding area (developed blocks). Colors may be varied. Exterior changes in color and/or materials shall occur at changes in plane and at inside corners or architectural features that break up the wall plane.
4. Hillside development in areas with a slope greater than 20% shall incorporate the following: Placing a proposed two-story second floor addition in a location as to not block more than 50% of the existing view as seen from the existing adjoining residential lots front or rear yard (ground level).

Picture Example: Diagrams showing methods to preserve view

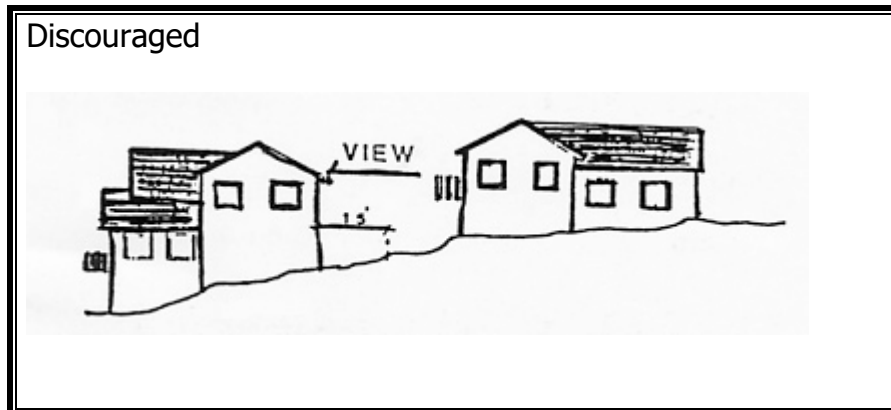
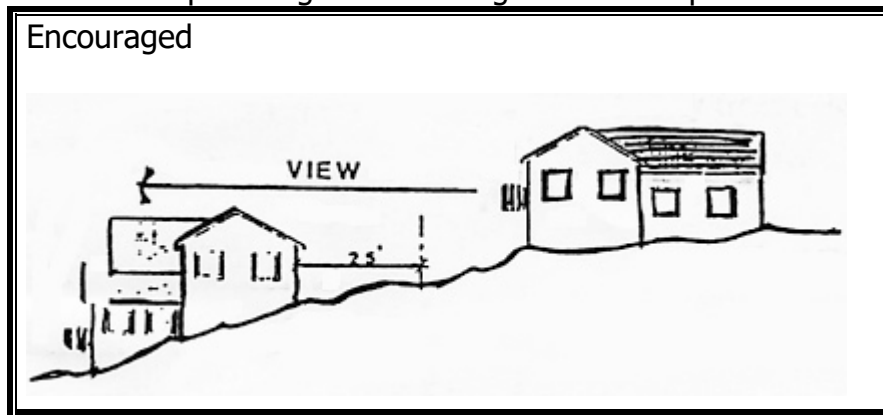

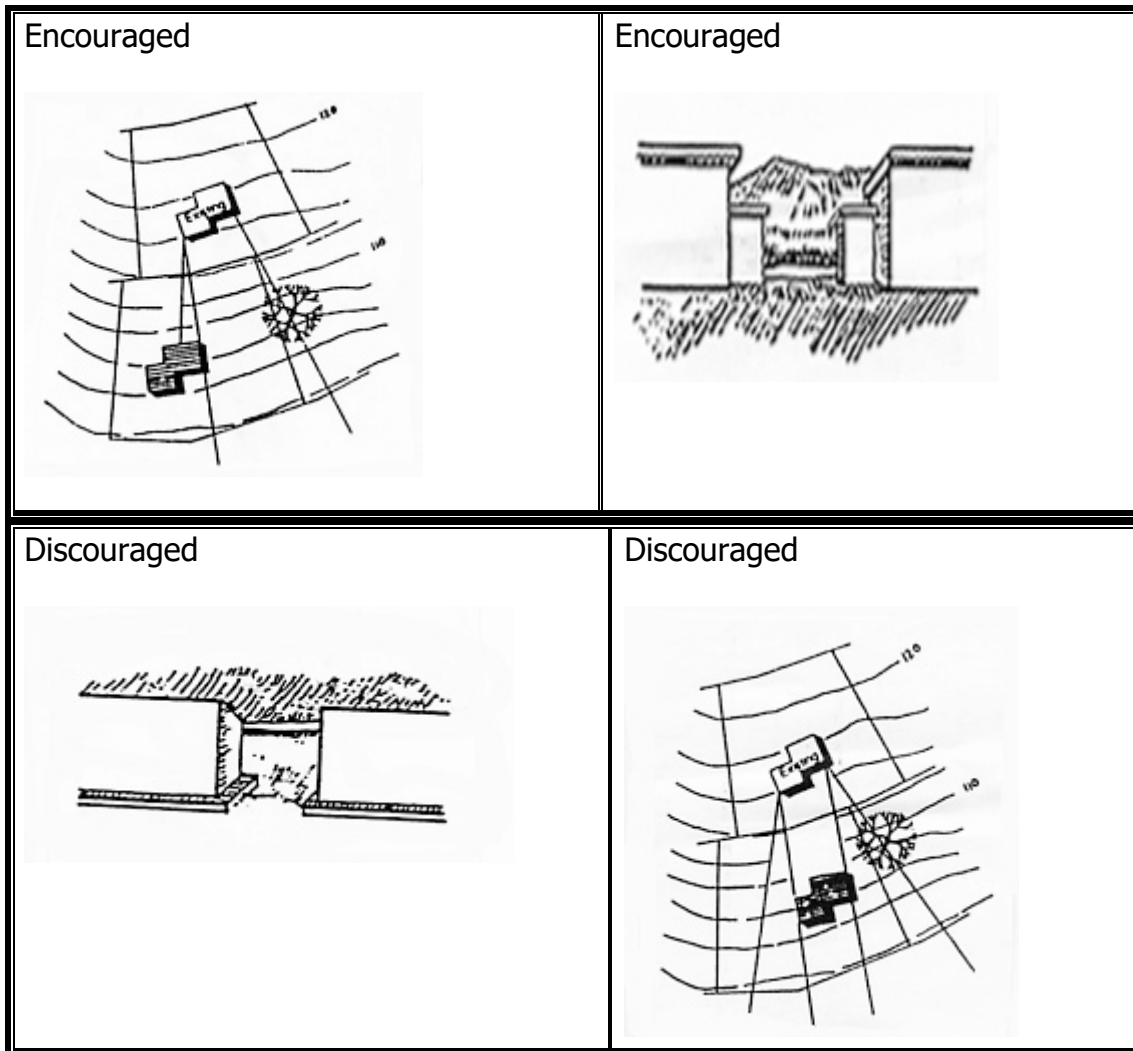

C. Exterior Colors

1. Colors may be varied. The colors of all elements of a development including walls, accessory structures, fences, bollards, and signs should be compatible with each other and with materials, architectural style, and details. Accent colors may be used but should not compete or be too bright.
2. Building color in built-up areas, characterized by a dominance of buildings, should be compatible and blend with surrounding buildings.
3. In commercial areas, color should be used to unify a building façade that is divided into many individual storefronts.
4. A building should be treated as consistently as possible on all sides. Color on side and rear walls should avoid harsh shifts in effect from the front or street facing walls.

5. Paint should not be used to conceal brick or stone.
6. Color on historic buildings should be compatible with the history of the area and the building. Historic color palettes based on research, old photographs, and historic records are encouraged.
7. Building color in hillside areas, characterized by a dominance of natural landscape, should emphasize a natural palette - earth tones, warm grays and greens-and allow the building to blend into the natural background.
8. A color plan showing the location of all colors on the building and color chips of colors (specifying model and manufacturer names/numbers) shall be submitted to the Planning Division for review and approval.

D. Materials

1. Highly reflective finishes are discouraged.
2. Metal buildings may be approved if they are compatible with surrounding buildings.
3. Any exterior changes in materials should occur at changes in plane and at inside corners.

Picture Example: Diagram showing location of appropriate change in materials vs. inappropriate location change

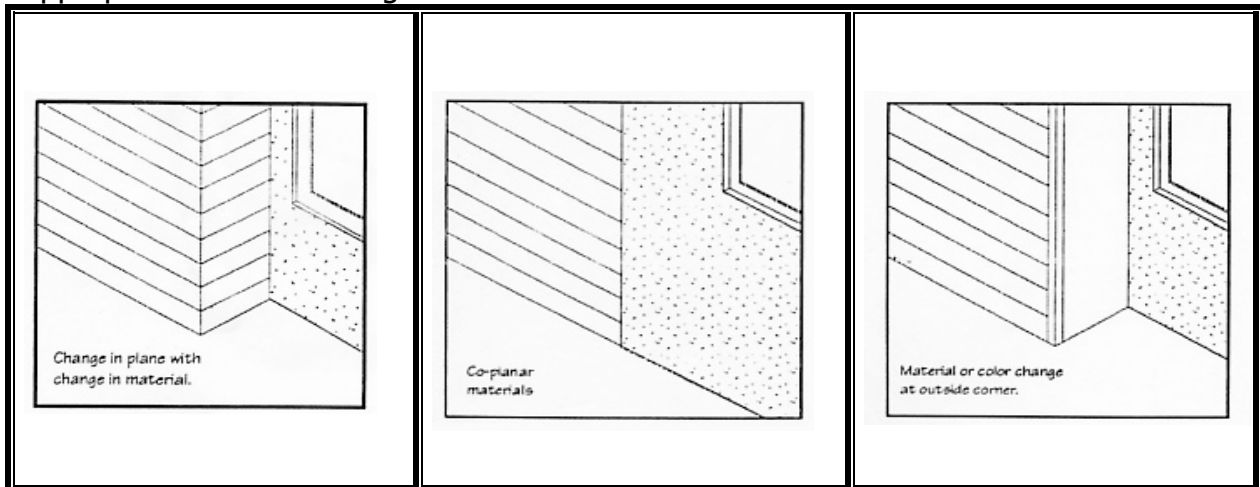

E. Lighting

Exterior lights should be architecturally compatible with the proposed project. New lights should not stand out in relationship to surrounding lights when viewed from a distance. The goal is to maintain the City's existing uniformity of lights as viewed from a distant vista or entrance into the City. These lighting guidelines are not intended to limit or otherwise restrict security or safe lighting practice.

1. **Exterior Lighting-Residential**

- a. Lighting should be subdued and utilized to provide enough illumination for safe access to the residence.
- b. All exterior lighting should be adequately controlled and/or shielded to prevent glare and undesirable illumination of adjacent properties and streets.

Picture Example: Light facing down (bulb covered) vs. exposed bulb light

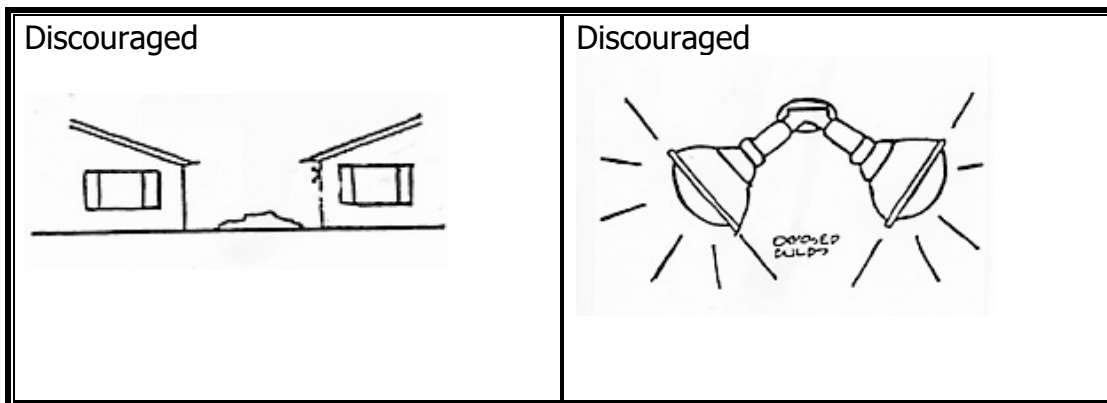
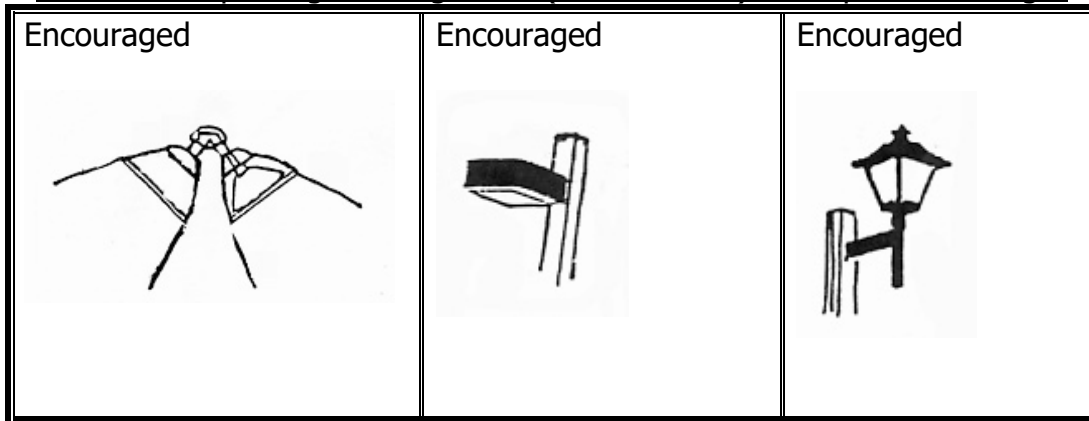

2. **Exterior Lighting-Commercial Industrial**

In addition to all applicable aspects covered under Exterior Lighting - Residential, lighting on sites used for commercial or industrial purposes shall comply with the following.

- a. High intensity lighting fixtures for the purpose of security shall not be substituted for site or landscape lighting or general building exterior illumination. High intensity lighting shall be limited to loading and storage locations or other similar service areas. There shall be no overspill or glare across property lines or onto the street.

- b. Pole mounted fixtures rather than wall mounted light fixtures shall be used to light perimeter parking lots unless determined otherwise by the Director based on the site design. These may be located within or at the outside edges of the lot. Perimeter lights should be down-lights with cut-off shields or otherwise be directed toward the interior of the lot.

Picture Example: Light facing down to ground vs. light facing away

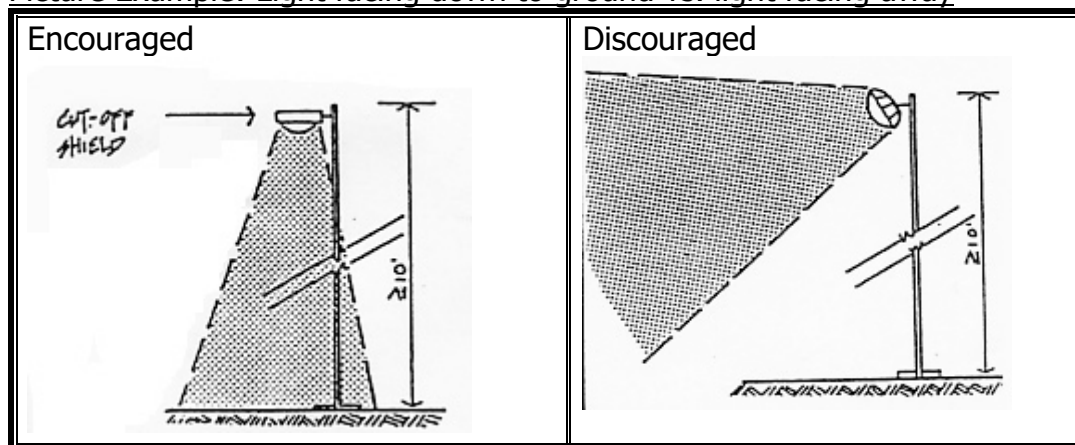

- c. Moving, flashing, rotating, twinkling and exposed neon accent lighting and wall mounted lighting that is intended to illuminate the building is prohibited, but may be used to accent architectural features.
- d. Lighting fixtures in parking garages and parking structures that are visible from the street and surrounding property shall be screened so that the light source is not visible.
- e. External signage lighting should be directed to the illumination of the sign without spillage.
- f. Lighting fixtures located at ground level should not create hazards to pedestrians along public access.

F. Accessory Equipment

All accessory equipment, including storage structures, mechanical equipment and electrical equipment shall be designed and placed to harmonize with the major structures on the site and with the neighborhood. The use of landscaping or other screening is encouraged.

- 1. Other Mechanical Equipment – To minimize the impact of mechanical equipment on the appearance of the building and the community, window air-conditioning units or condenser elements shall not be located on the front facades. Antennas should be located where they are not visible

from the front elevation. Mechanical equipment on the ground shall be screened with the fence or plant materials or housed in a structure that harmonizes with the surroundings. Mechanical equipment (including but not limited to Air Conditioning units, water heaters/tanks, pool equipment) on the ground that is less than 6 feet in height and take up less than 120 square feet of space do not need to comply with Zoning Code section 17.304.20 pertaining to the 5 foot separation requirement to the primary/accessory structures.

- 2. All visible projections, including but not limited to new gutters, vents, pipes, flashing, utility boxes, fire extinguisher boxes, downspouts, and chimney flues, should be kept as low as possible and covered or painted to blend with the colors of the building or roof.
- 3. Refuse collection areas shall be located or screened to minimize public view.

Picture Example: Placement and concealment of wires vs. exposed wires

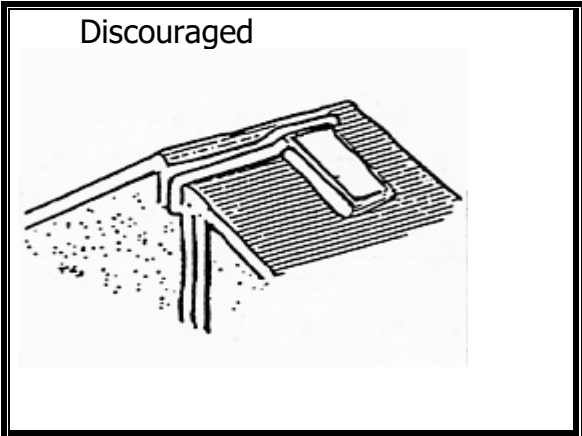
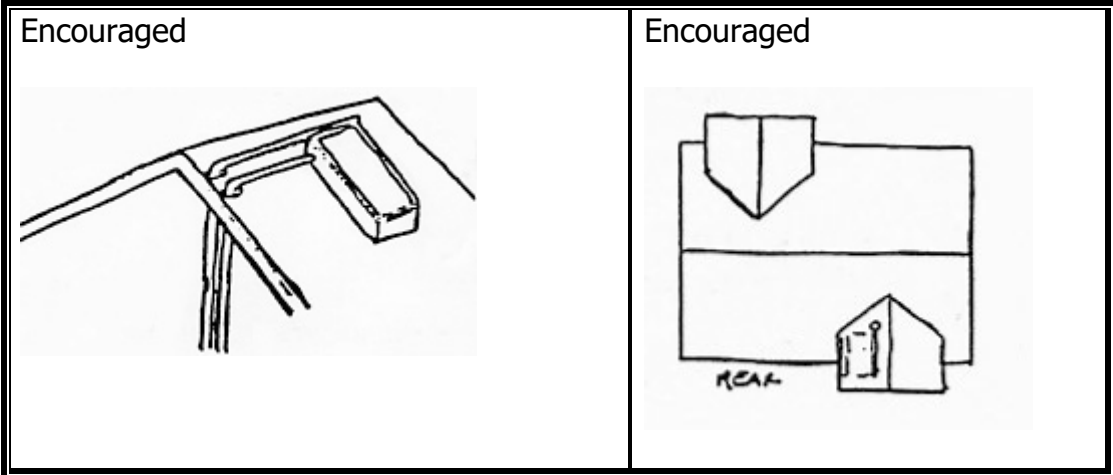

G. Awnings

1. Awnings should not be installed under significant eave overhangs, cantilevers, or other prominent architectural projection.
2. Bright, highly saturated colors (colors with a high chroma with a value of 4, 5, or 6 on the Munsell color system), reflective materials and brightly illuminated back lighting of transparent materials should be avoided in the awnings. The Planning Division may request documentation about the color from the manufacturer before approving brightly colored awnings.
3. Solid colors and/or low contrast stripe patterns are permitted awning color treatments.
4. Awning colors should not be changed by painting over the awning. Rather, a new awning fabric should be used.
5. Awnings on historic buildings should be compatible with the history of the area and buildings. Historic colors, styles, and mounting locations based on research, old photographs, and historic records are encouraged.
6. Uniform shape, color, and placement should be used when multiple awnings are proposed for a single building. New awnings generally should match any existing awnings on the building.
8. Awnings shall be maintained in good repair and in a clean and attractive condition. Torn, bent, or faded awnings shall be repaired or replaced.

H. Landscaping and Open Space

1. Trees and Vegetation

- a. Significant trees and vegetation shall be protected, preserved and/or replaced during site design and construction of any building, as detailed below. The applicant shall adhere to the Lompoc Tree Ordinance and Lompoc City Code Sections 12.32.050 and 12.32.060 and 15.52.010 through 15.52.030.
- b. The design and placement of all buildings should incorporate existing, healthy, and visually prominent trees into the site design. Prominent trees are those of sufficient size and health that they have significant visibility to public streets.
- c. Landscaping should be used to blend the structure with the environment.

2. **Plazas and Courtyard**

- a. Outdoor areas should be comfortable and have enclosed boundaries or a focal point.
- b. Outdoor public spaces should provide comfortable seating for conversation and places to rest.
- c. Landscaping, monuments, art work, and water elements are encouraged.
- d. Public places with defined boundaries and protection from automobile noise and fumes are encouraged.
- e. Fountains and water features should be designed to look attractive with or without water.

3. **Open Space-Multi-Family**

In multi-family residential units, both private and common usable open space shall be provided in accordance with the zoning district the property is located in per the Zoning Code. Private usable open space for each dwelling unit shall be directly accessible from the unit (this can include decks/balconies, patio areas, gardens, etc.) to permit outdoor living opportunities. Common areas should be readily accessible from all buildings and integral to the on-site pedestrian system.

I. Parking

1. Parking lots and loading areas shall incorporate screening from adjacent streets. This may be accomplished by landscaping, fences, walls, screen structures, buildings, or combinations of any of these. All screening must be provided on site.
2. Landscape planting which is used for parking lot screening shall be consistent with 17.312.050 and provide a visual barrier of at least 75% opacity (within two (2) years after planting).
3. Parking lot screen structures shall be compatible in design, quality, color, and materials of the project buildings.
4. Parking lots and driveways for parking lots shall be constructed of concrete or asphalt.

Picture Example: Landscaping with wall to screen parking lot



J. Fences and Walls

In addition to other requirements in the code, developer must comply with the following:

1. Earth tone colors and native, natural materials should be used.
2. Vegetation and landscaping shall be integrated with the fence and wall design to soften the appearance. This can be accomplished by placing landscaping in front of the fence/wall.

Picture Example: Wall with offsets for residential subdivision or commercial/industrial complex facing public street

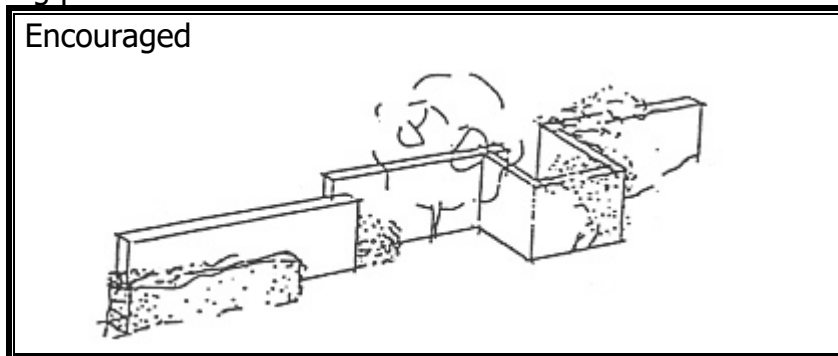

K. Commercial

The following guidelines are specific to Commercial zones (CC, CB, OTC, PCD):

1. Commercial centers abutting residential areas shall reduce noise and light penetration impacts, but should allow for pedestrian access.
2. Street furniture and accessories should be consistent throughout vehicular and pedestrian areas.
3. Public art is encouraged and should be appropriate to the location.
4. Loading areas should be located where they can function efficiently without detracting from the aesthetics of the commercial structure. Loading facilities should not be located at the front of structures. When it is not possible to locate loading facilities at the rear of the building, loading docks and loading doors should not dominate the frontage. The docks should be screened from the street by landscaping.
5. Permanent outdoor storage shall be in compliance with Zoning Code section 17.216.050.A, however, storage in commercial zones cannot be the primary use. In addition, since outdoor storage is not a use listed in Zoning Code section 17.212.030 (Allowed Land Uses), uses not listed may be allowed in compliance with Section 17.520.050 (Allowable Uses of Land).

L. Industrial

The following guidelines are specific to Industrial zones (BP / I):

1. Shall be in compliance with the requirements specified in Zoning Code section 17.216.040 & 050.
2. All industrial facilities shall be designed to reduce the impacts of noise, dust, fumes, and other nuisance conditions.
3. Exterior support equipment should be placed in a location where it best integrates with the building's architecture and can serve the business.

V. ADDITIONAL GUIDELINES FOR SPECIFIC ZONES

In addition to the above guidelines, the following guidelines must be met for the designated building type. If there is a conflict between the general guidelines set forth above and the specific guidelines which follow, the specific guidelines shall prevail.

A. Public Facility

There will be specific guidelines prepared at a future date consistent with Zoning Code section 17.220.

B. Mixed Use

There will be specific guidelines prepared at a future date consistent with Zoning Code section 17.220 and 17.404.150.

VI. ADDITIONAL GUIDELINES FOR SPECIAL DISTRICTS AND SITES

The Old Town area of the City is unique which require special guidelines. In addition to the Zoning Code requirements for the Old Town (OTC) zoning district (17.212), the above guidelines are applicable, and compliance with the specific guidelines below is required. If there is a conflict between the guidelines set forth above and the specific guidelines which follow, the specific guidelines shall prevail.

A. Old Town

1. Purpose

The Design Guidelines in Old Town Lompoc are intended to promote future development that will:

- a. Stimulate investment in and strengthen the economic vitality of Old Town Lompoc; and,
- b. Renew a positive physical image and identity of Old Town Lompoc.

These guidelines acknowledge the prevailing architectural characters and development patterns within Old Town. The guidelines, therefore, do not seek to impose an overriding style, a limited color palette, or an artificial theme. They do seek to assist in promoting the positive design characteristics existing throughout Old Town.

It is not the intent of these design guidelines to eliminate or discourage innovative design. The design guidelines complement the mandatory development standards contained in the City of Lompoc Municipal Code by providing examples of design solutions and by providing design standards of the various mandatory regulations. The guidelines include a combination of quantitative mandatory development standards and standards that may include some flexibility in the application to specific projects.

The construction of new buildings and rehabilitation of existing buildings within the Old Town Commercial District (OTC) in Lompoc is important for continued economic growth and diversity in the City. It is extremely important that new buildings erected in Old Town are compatible with existing buildings which reflect the architectural styles of the early to mid twentieth century.

Building façades, including the storefront, are the most important visual elements of commercial structures. Façades also experience significant change during a building's life and hold the most potential for creative alterations affecting both the character of the building and the streetscape. In an effort to promote quality design for new infill buildings, and the rehabilitation of existing buildings, the following specific storefront and façade guidelines are presented.

Public space associated with commercial buildings in Old Town Lompoc should serve as a transition from the outside to the inside of the buildings, should be complementary to the commercial buildings and should be supportive of pedestrian activity. Public areas should clearly communicate that all members of the public may occupy the space and communicate this message by being designed as extensions of the public space of the sidewalk. Methods of doing this include providing pedestrian amenities such as benches, fountains, and continuing the hardscape of the sidewalk. Successful public spaces also act as well-defined transitions from street and sidewalk to building door and interior spaces. Public space can add to the vitality of commercial areas, when designed and located in a manner that attracts pedestrian activities.

2. **Organization**

The design guidelines are organized into the following sections:

- a. *Purpose* provides an overview of the purpose, organization, applicability, and other aspects of the design guidelines.
- b. *Design Criteria* establishes basic rules of thumb for integrating new development into the existing urban fabric of Old Town Lompoc and emphasizes the treatment of the Edge condition of existing and proposed development.
- c. *Old Town Commercial District* provides design guidelines, within an historic architectural context, for uses in the Old Town Commercial District of Lompoc. This section provides general design considerations as well as detailed guidance on specific subject area. It is divided into three categories: 1) architectural guidelines; 2) infill; and 3) storefront design.

- d. *Landscaping and Public Spaces* provides a basic landscape and plaza design framework which is to be used in conjunction with new development and infill, and as a helpful tool for property owners interested in upgrading the landscaping of existing developments.
- e. *Designing for Crime Prevention* establishes numerous standards and guidelines to ensure that safety and security concerns are incorporated into new development and public improvements.
- f. *Secretary of the Interiors Guidelines* identifies the minimal standards for the rehabilitation of historic structures, sites, and buildings.

3. **Interpretation**

To aid the interpretation of these guidelines, a development applicant should understand the meaning of shall, should, encouraged, and discouraged:

Guidelines which employ the word “shall” are intended to be mandatory requirements to be complied with and adhered to. The word “should” is also required, however, an alternative measure may be considered if it meets or exceeds the intent of the guidelines.

Guidelines using the words “encouraged” or “discouraged” are not mandatory, but express a desirable design solution.

4. **Applicability**

The provisions of this section are applicable to all development within the Old Town Commercial District.

Any new building, additions, exterior alterations, or landscaping, and any modification to an approved landscaping plan or parking lot design shall adhere to the Design Guidelines as applicable. It is important to note, however, that these Guidelines do not affect existing buildings which are not proposed for new construction, exterior alterations, landscaping or changes in the parking lot layout.

The Design Guidelines will be utilized during the City’s Development Approval process (and should be provided to applicants during pre-application conferences), to encourage the highest level of design quality and at the same time provide the flexibility necessary to encourage creativity on the part of project designers in response to existing site conditions.

5. **Exemptions**

When in compliance with all other City ordinances, and with the standards and provisions of the following projects are exempted from all provisions of these Design Guidelines:

- a. Construction underground, which will not leave any significant, permanent marks (something that lasts or continues for more than 2 years) on the surface after completion. Utility boxes, pipes, and poles shall be considered significant permanent marks.
- b. Maintenance work on buildings, landscaping, or grounds (including parking lots) which does not significantly alter the appearance or function of the building, landscaping, or grounds.
- c. Interior remodeling work.
- d. Landscape maintenance and upkeep, including relatively minor replacement of plants other than trees.
- e. Temporary uses and structures as defined by the Lompoc Municipal Code.
- f. Routine roof maintenance and repair. Overall roof reconstruction is subject to these Design Guidelines.
- g. Changes to exterior façade color only require staff level review. A color plan showing the location of all colors on the building and color chips of colors (specifying model and manufacturer names/numbers) shall be submitted to the Planning Division for review and approval.

6. Context & Compatibility

Existing buildings, streetscape, and landscaping establish the frame of reference for new development. This is particularly true throughout Old Town Lompoc where an historic urban fabric is well represented by traditional commercial structures such as the Lilley Building (101 North H Street) and the building on 111 West Ocean, and by art-deco styles exemplified in the Rudolph Building (105-107 South H Street). To the extent that the scale, placement, and character of new buildings or building additions blend with what is already there, Old Town is continuously woven together. Conversely, regular or blatant disregard of existing patterns disrupts the essential character image, creates voids in the built environment, and compromises the functionality of Old Town.

Generally, to create harmony between the existing urban fabric and new elements introduced into Old Town, all new structures, additions, and uses should be compatible with the prevailing historic architectural character of the surrounding area. Existing site amenities, such as trees, should be preserved and should become part of any new project or addition, and structures and activities should be located and designed to avoid creating nuisances and hazards for adjoining properties, particularly residential properties.

The concept of “compatible” design is one of the most important concepts to recognize when using these design guidelines. Compatible designs do not seek to imitate the historic architecture found in Old Town, but do reflect their surroundings in terms of design concepts – mass, scale, rhythm, color, materials, and building arrangement. Compatible designs will be in harmony with the best designs of surrounding developments.

Guidelines pertaining to compatibility include:

- a. All new construction and development should incorporate those characteristics of Old Town that exhibit a positive distinctive architectural style and/or established functional or landscape patterns.
- b. New buildings and additions should be sited in a manner that will complement rather than conflict with existing adjacent buildings, landscape, streetscape, parking, and access.
- c. Transitions between existing and new buildings or additions should be gradual. The height and mass of new projects or construction should not create abrupt changes from those of existing buildings.
- d. Natural amenities, such as mature trees and views, should be preserved and incorporated in the design of Old Town projects where applicable. Buildings should not back up to amenities without incorporating landscaping buffer of at least 1 foot in depth.
- e. Buildings should be oriented to connect with high activity areas, such as restaurant dining areas or major pedestrian areas, in order to create connections and linkages.
- f. Noise or odor generating activities, loading areas, trash and storage areas and rooftop equipment in particular should be located at least 5 feet from adjacent residences and not next to residential properties without implementing methods to reduce their negative effects. They shall also be screened from view on all major streets and side streets in Old Town.
- g. Where Old Town buildings are adjacent to residential neighborhoods, Old Town buildings should maintain low profiles and heights should be stepped down to the height of adjacent residential zones, utilizing architectural elements such as gables or hip roofs to reduce building mass.

- i. Windows in commercial and other non-residential buildings should be oriented to preclude a direct line of sight into adjacent residential buildings, or property.

7. **Design Criteria**

a. Infill

Since these buildings will be constructed on vacant or underutilized lots, thus filling in the street frontage, they are called "infill" construction.

The design of an infill building, particularly its front façade, should be influenced by the other façades on the street. The infill structure should be compatible with surrounding buildings in terms of mass, scale, height, façade rhythm (openings, windows and/or doors, and architectural features that trace across the wall surface), placement of doors and windows, storefront design, color and use of materials.

Since good infill design responds directly to its surroundings, it is not possible to develop specific guidelines which apply in every case. There are, however, several general design principles which should govern the visual ties between a new infill building and its neighboring historic structures found in Old Town Lompoc.

i. Façade Proportion

- (a) The characteristic proportion (relationship of height to width) of existing façades should be compatible to new infill development.

ii. Horizontal Rhythms

- (a) Whenever an infill building is proposed, identify the common horizontal elements (e.g. cornice line, window height/width, and spacing) found among local historic structures and develop the infill design utilizing a similar rhythm or alignments.
- (b) If maintaining a horizontal rhythm or alignment in an infill building is very difficult or otherwise impossible, the use of fabric canopies or awnings is strongly encouraged to establish a shared horizontal storefront rhythm.

iii. Wall Articulation

- (a) Long, blank, unarticulated street wall façades without window or door openings are strongly discouraged.
- (b) Monolithic street wall façades should be “broken” by vertical and horizontal articulation (e.g. sculpted, carved, or penetrated wall surface defined by recesses and reveals) characterized by: (a) breaks (reveals, recesses) in the surface of the wall itself; (b) placement of window and door openings; or (c) the placement of balconies, awnings, and canopies.
- (c) Avoid large unbroken façade surfaces at the storefront level. This can be achieved in a number of ways including: (a) dividing the façade into a series of display windows with smaller panes of glass; (b) constructing the façade with small human scale materials such as brick or decorative tile along bulkheads; (c) providing traditional recessed entries; or (d) providing consistent door and window reveals (i.e. forms a box structure to which a window or door frame is attached).

iv. Roofs

- (a) Roofs may be flat or sloped consistent with surrounding buildings. Older twentieth century commercial vernacular buildings used flat roofs with decorative parapets and heavy cornice lines. The visible portion of sloped roofs should be sheathed with a roofing material complementary to the architectural style of the building and other surrounding buildings.
- (b) Cornice lines of new buildings (horizontal rhythm element) should be aligned with buildings on adjacent properties to avoid differences in building height.
- (c) Radical pitches such as A-frames, massive mansards, geodesic domes, or chalet style buildings are strongly discouraged.
- (d) The use of decorative parapets is encouraged.

v. Building Material Palette

Building materials to be used on infill buildings are to be consistent with the materials used on significant adjacent buildings.

The following are recommended materials for infill structures (not including existing buildings): Building Wall – Clear glass, glass block (storefront only), glass block (transom), exterior plaster (smooth trowled), new or used face-brick, cut stone, rusticated block (cast stone), horizontal clapboard, lap, wood siding, ceramic tiles (bulkhead), stucco, horizontal plastic clapboard. Roofs (where visible): standing seam metal roofs, class “A” composition shingles (limited to refurbishment of residential structures).

vi. Mechanical Equipment Screening

Any mechanical or utility equipment (whether on the roof, side of building, or ground) shall be screened (consistent with Zoning Code section 17.312.040.G). The method of screening shall be architecturally integrated with the structure in terms of materials, color, shape, and size. On-roof mechanical equipment shall be screened by a continuous solid screen such as building elements (e.g. parapet wall, roof well).

Picture Example: Parapet architectural feature screening roof mechanical equipment

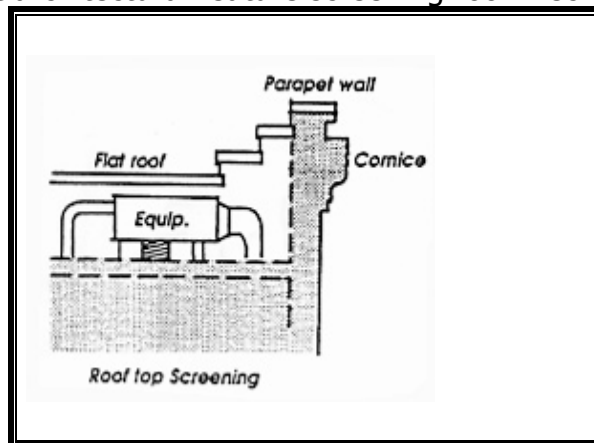

vii. Setbacks and “Build To” Lines

- (a) The build to requirements shall adhere to Zoning Code section 17.212.040.
- (b) Canopies, trellises, and other accessory structures which are open and do not restrict pedestrian or vehicular movement may project over the right-of-way with City or Caltrans encroachment approval.

viii. Street Orientation

- (a) Shall be consistent with Zoning Code section 17.212.050.B.

ix. Parking Lot Orientation

- (a) Shall be consistent with Zoning Code section 17.212.050.B.
- (b) Rear parking lots and common access driveways shall be designed and located contiguous to each other so vehicles can travel from one private parking lot to the other (reciprocal access) without having to enter the street.
- (c) Private parking lots with side street frontage should be landscaped with trees and shrubs in order to continue the linear street frontage created by the existing buildings and to screen parked vehicles. Provide low masonry garden walls or landscaping (three (3) feet maximum height) near setback line to screen parking from the side street.
- (d) Locate parking lot entries on side streets in order to minimize pedestrian/vehicular conflicts along the primary street frontage.
- (e) Design parking areas so that pedestrians walk parallel to moving cars. Minimize the need for the pedestrian to cross parking aisles and landscape area.
- (f) Parking garages should be designed to fit in with the existing developments in Old Town Lompoc.
- (g) Parking garages should provide access to retail stores at the sidewalk level.

Picture Example: Diagram showing parking structure with retail on first floor front of building vs no retail and blank wall

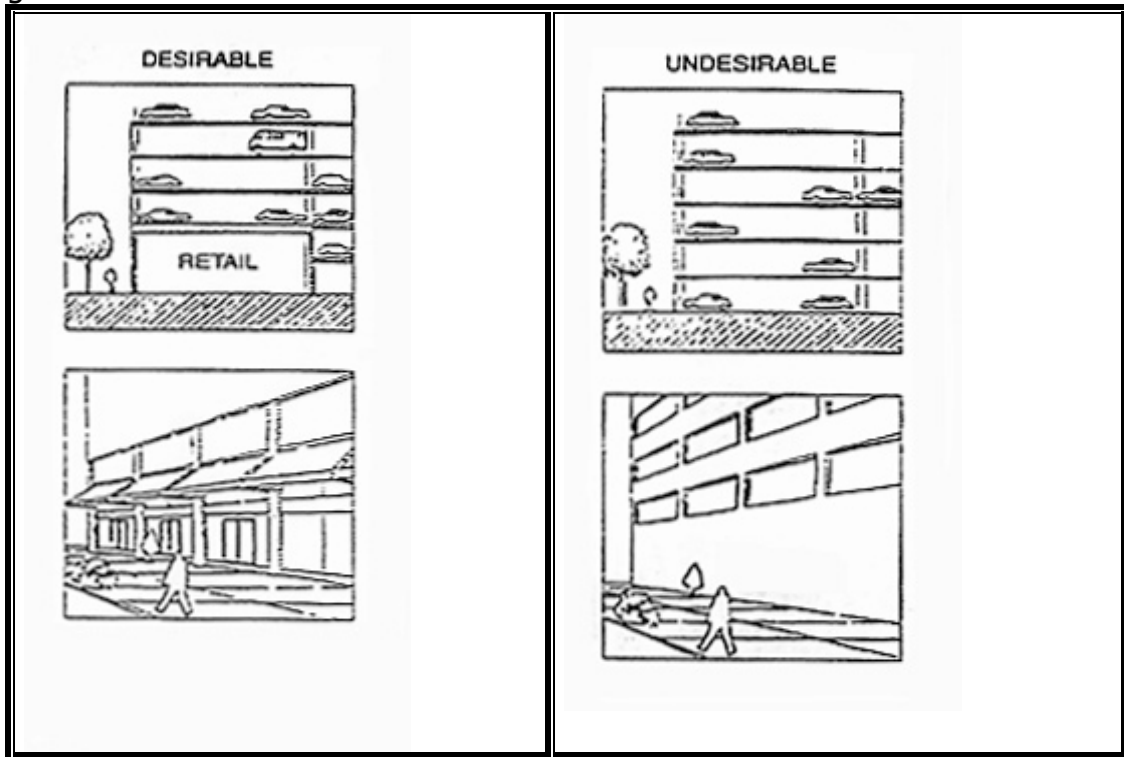

b. **Storefront Design**

i. Entries/Doorways

Commercial storefront entries are typically recessed and/or sheltered by a covered arcade structure, canopy, or awning. This provides more area for display space, a sheltered transition area to the interior of the store, and emphasizes the entrance. Recessed entries should be retained and are strongly encouraged in new storefront construction.

ii. Facade Color

- (a) The use of light, subdued, or neutral (earth tone) colors and natural building materials, such as brick, wood, or stone are recommended.
- (b) Different window frame and sash colors are encouraged but should complement the main color of the building.

- iii. Awnings and Canopies
 - (a) Awning shape should relate to the window or door opening. Barrel shaped awnings should be used to complement arched windows while rectangular awnings should be used on rectangular windows.
 - (b) All awnings should be well-maintained, washed regularly and replaced when faded or torn.
- iv. Door and Window Design
 - (a) Use of clear glass (at least 88% light transmission) on the first floor is required consistent with 17.212.050.
 - (b) Storefront windows should be no closer than 18 inches from the ground (bulkhead height). By limiting the bulkhead height, the visibility to the storefront displays and retail interior is maximized. Maximum bulkhead heights for new construction shall be 36 inches.
 - (c) Discourage introduction or change of the location or size of windows or other openings that alter the existing building architectural or character of the original building.
 - (d) Air conditioning units placed in individual windows and window transom areas are prohibited.
 - (e) Permanent, fixed security grates or grilles in front of windows are prohibited. If security grilles are necessary, they should be placed inside the building behind the window display area.

Picture Example: Illustrating storefront and transparency requirements

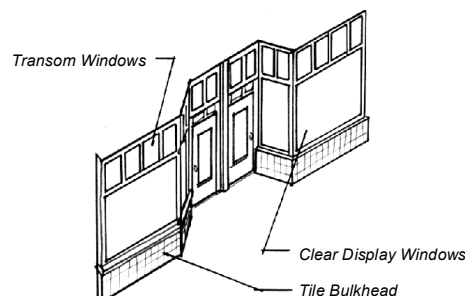

v. Rear Entrances

- (a) An awning can soften rear façades and provide protected space.
- (b) Security lighting should focus on the rear entry door.

Picture Example: Awning covering rear of building



vi. Window Replacement

- (a) If a window has deteriorated beyond repair or is missing, the replacement should match the original window in terms of design and materials. Replacement windows should always fill the entire existing opening and duplicate the original window pattern. For example, a double hung sash window should not be replaced by a single fixed pane of glass.

vii. Door Replacement

If possible, maintain and repair an original door.

viii. Removal of Existing Canopies and Metal Awnings

When existing metal canopies are removed they should be replaced with fabric awnings, consistent with the architectural style of the building.

ix. **Preserve Traditional Decoration**

Many times, in the remodeling of storefronts, original decorative details are intact as visual “leftovers” or simply covered up with new construction. If the building is to be refurbished, these details should not be wasted. If enough of them remain, they can be restored as part of the original design. If only a few remain, they can be incorporated as design features in a new storefront. In either case, the design of any improvements should grow out of the remaining traditional details and create a harmonious background which emphasizes them.

8. Landscaping & Public Spaces

a. **Introduction**

Landscaping in Old Town Lompoc shall achieve three specific ends:

- ❖ to beautify Old Town
- ❖ to soften commercial development
- ❖ to unify the area as a pleasant environment for residents and visitors alike
- ❖ Compliance with LMC sections 17.312 (Landscape and Screening Standards) and 17.212.050.B (Old Town Commercial Zone).

These three ends will be accomplished by a recognizable use of repeated planting treatments. Consistency and continuity within the street right-of-way and building setback areas is extremely important.

b. **General Landscape Design Guidelines**

All development is encouraged to follow these general landscape guidelines:

- i. Save healthy existing mature trees.
- ii. Use specimen trees (boxed trees) for immediate effect and accent.
- iii. Give consideration to rapidly growing trees.
- iv. Emphasize use of varieties which require low maintenance in public and commercial areas, especially in large landscape areas.
- v. Use boxed and potted plants in clay, stone, or wood containers, especially for enhancement of sidewalk shops. The

color and style of the containers shall be subject to approval by the City when in public right-of-way.

- vi. Promote ground covers which require little maintenance.
- vii. Vines and climbing plants integrated upon building and perimeter garden and building walls are strongly encouraged.
- viii. The use of materials such as crushed rock, redwood bark chips, pebbles, and stone or masonry slabs should not be used in place of live plant materials but can be used as accent materials in landscape areas. Use of such materials shall be subject to review and approval through landscape plan review (when required).
- ix. Use color plantings at the base of a building in planter boxes, and focal points.
- x. Trees should be planted using industry accepted methods. Trees and shrubbery should not be located so that they interfere with the effectiveness of parking lots, street lighting, and storefronts.
- xi. Landscaping should not obstruct the sightlines of motorists or pedestrians, especially at pedestrian crosswalks.
- xii. Trees and shrubbery should not be located so that they interfere with the effectiveness of parking lot and street lighting.
- xiii. Landscaping material, so long as it is properly maintained, is the preferred method used to obscure the view of any parking or storage area adjacent from a public street or pedestrian area.
- xiv. Landscape screen plant materials should be large enough at planting to provide effective screening, and be capable of growing to the height and density desired within a reasonable period of time.
- xv. All commercial projects should provide complete drip irrigation systems.
- xvi. Keep all plants healthy and growing with all planting areas free of weeds and debris.

- xvii. Comply with the California Municipal Water Efficient Landscape Ordinance (MWELo).

c. **Public Spaces**

i. Plazas

- (a) Plazas should be designed to supplement, rather than detract from street activity.
- (b) The function and appearance of the plaza or courtyard should not be dominated by stairs or elevators.
- (c) Where inconsistent setbacks occur along the street in Old Town, plazas should be considered to compensate for the broken building edges.
- (d) Retail shops, restaurants, offices, or other activity-generating uses should be located at the edges of plazas; blank walls should be minimized adjacent to such pedestrian spaces.
- (e) Plazas should be designed with unimpeded lines-of-sight to and from the public sidewalk; and physical access should be provided from the public sidewalk to plazas.
- (f) Plazas should be physically and visually accessible from the public sidewalk. Security fences, walls, and entry gates shall not block the sidewalk edge of the plaza or views into the plaza. At least 15 feet of building frontage should be transparent or visually penetrable to provide entry to and views into the plaza.
- (g) Entries to the plaza, and storefront entries within the plaza, shall be designed and lighted so they do not create hiding places.
- (h) Visual features, such as public art or a fountain, should be incorporated in plazas to attract pedestrians.
- (i) Seating should be provided in plazas. Where applicable, plaza users should be provided with a choice between active (i.e. observing nearby activity) and passive (i.e. private) seating.

- (j) Shade trees or other elements providing relief from the sun should be incorporated within plazas, in a manner that does not impair pedestrian movement.
- (k) A majority of the gross area of the plaza should have access to sunlight for the duration of daylight hours. A mix of direct sunlight and shade should be provided. No more than 30 percent of a plaza should be covered with a roof. Canopies, awnings, cantilevered overhangs, or balconies may project over the ground floor but should not prohibit the penetration of sunlight to the ground floor.
- (l) At least 10 percent of the plaza's surface should be landscaped. Shade trees are strongly encouraged.
- (m) Paving and furniture used in private plazas should complement streetscape elements used in the public right-of-way throughout Old Town Lompoc.
- (n) Plazas should provide at least one sitting place for each 200 square feet of plaza in addition to permitted outdoor dining.
- (o) Plazas, including all entrances and exits, should be fully illuminated ½ hour after sunset to ½ hour before sunrise to facilitate natural surveillance opportunities and to discourage illegitimate activities. Lighting should be designed to help define, order, and further develop the design concept of the space in a manner that appears welcoming to pedestrians.
- (p) Signage or other mechanisms should identify that the plaza is available for public use during business hours.
- (q) Security gates and security fencing may not be used in plazas unless gates and fencing comply with the standards contained within the zoning district, comply with LMC 17.312 (Landscape and Screening Standards) and reviewed and approved by the Director.
- (r) Landscaping for the plazas should provide special interest through plant materials with integral interest such as special foliage color, seasonal changes in plant habit, scent, or floral display.

ii. Entry Courtyards

- (a) Courtyards, where used, should include a focal element of sculpture and/or water, simple plantings and simple sitting niches with a view of the activity within the space.
- (b) Courtyard trees should be drought tolerant and be planted in simple geometric symmetries.
- (c) Courtyards should be designed to provide both visibility and separation from the street.

iii. Public Art

- (a) Art associated with commercial buildings in Old Town Lompoc that invites participation and interaction, adds local meaning, interprets the community by revealing its culture or history, and/or captures or reinforces the unique character of a place is encouraged (i.e. murals, kinetic sculptures).
- (b) The setting of public art should be considered in its design; likewise, the impact of physical space and nearby structures on public art should be considered.

9. **Designing for Crime Prevention**

The concept of crime prevention through environmental design (CPTED) includes a wide variety of strategies aimed at reducing opportunities for crime through the proper design and effective use of the built environment. Key components of CPTED include:

- ❖ Natural access control involving the use of pathways, paving treatments, lighting, landscaping, fencing, signs, and other built features to guide ingress and egress and to discourage or eliminate public access into areas.
- ❖ Natural surveillance focusing on the placement and design of physical features and the arrangement of uses to maximize opportunities for natural surveillance.

a. **Design Considerations**

CPTED involves design of physical space in the context of the needs of the bona fide users of the space, the activity planned for the space and the predictable behavior of bona fide, as well as, illegitimate users. The

following CPTED-based guidelines are to be considered for all development within the Old Town area.

- i. Utilize plants and low fencing to direct movement and restrict, symbolically, areas where people should not enter.
- ii. Minimize the height of parking lot screening (shrubs or low walls) to allow a visible “window” above three (3) feet and below seven (7) feet.
- iii. Restrict the number of entry points into a development or parking lot.
- iv. Improve safety behind buildings through use of:
 - (a) adequate security lighting;
 - (b) limited access (walls, fences, gates, shrubs);
 - (c) introduction of activities (e.g. rear entrances for commercial activities) that increase surveillance;
 - (d) surveillance through windows or with cameras; and
 - (e) maintenance storage areas and alleys.
- v. Use security fencing/walls with view ports or sections of wrought iron grille work to allow views into the development while restricting access.
- vi. Identify building numbers (street addresses) by posting numbers so they are visible from the public right-of-way wherever possible.
 - (a) Single-family homes should use six inch numbers/letters (in height) when displayed at the first story level.
 - (b) Buildings other than single-family homes should use twelve inch numbers/letters (in height) when displayed at the first story level.
 - (c) Building numbers/letters displayed above the first story should be a minimum sixteen inches in height.

- (d) Multiple-family residences should include building numbers of four inches in height if illuminated and six inches if non-illuminated.
- vii. Multi-tenant developments (residential and non-residential) should include directories at site entrances identifying the locations of buildings, suites, apartments, etc. and on-site landmarks, including management offices and access points.
- viii. Factors to consider in the design of new development, as related to public safety and crime, include:
 - (a) Types and characteristics of adjacent or nearby uses;
 - (b) Determine whether the development is intended to serve as a buffer, barrier or transitional use between different existing buildings/uses. Design features and configurations can optimize compatibility with those uses;
 - (c) Determine who are the intended users of the development and how the site can be designed to encourage desirable use while discouraging illegitimate activities;
 - (d) The internal activities of the building should relate to one another and to external activities. Consideration should be given to how the building design elements influence the activities;
 - (e) Consider the location of off-site pedestrian/bicycle and vehicular circulation systems in relation to the development, and how can the proposed structure would best relate to the circulation areas;
 - (f) The on-site circulation areas (entrances, exits, loading area, refuse collection/service zones, parking lots, plazas, paseos, sidewalks, etc.) should provide safe environments while facilitating the intended use of the structure. Also, consider how the relationship between the building(s) and the circulation system elements can be enhanced to promote safety;
 - (g) Window placement, lighting, parking areas, signs, landscaping, waiting areas, plazas, sidewalk-oriented uses, etc. should be designed to maximize natural surveillance;

- (h) Design treatments should be introduced to make certain features less susceptible to criminal activity or less likely to permit illegitimate activity (e.g. doors, windows, alleys, loading areas, refuse enclosures, fences, gates, etc.);
- (i) Landscaping should be incorporated and maintained to facilitate natural surveillance (i.e. sight lines and visual clearance areas); and
- (j) Investigate opportunities to use landscape materials to communicate territoriality and to incorporate plazas into the design of pedestrian linkages is highly encouraged.

10. **Secretary of the Interior's Standards for Rehabilitation**

- a. The Secretary of the Interior's Standards for Rehabilitation is codified in the Code of Federal Regulations 36 CFR Part 67.

B. Airport

Additional standards and requirements apply in the Lompoc 2030 General Plan, LMC section 17.224.050.A (Airport Overlay Zone), Lompoc Airport Master Plan, and the Lompoc Airport Land Use Compatibility Plan.

VII. DEFINITIONS

Awnings – A roof-like structure, generally of canvas or metal material, that is stretched and/or supported by a metal or wood frame.

Commercial Centers – Shopping facilities located throughout the City which provide goods and services to patrons. These range from single facilities such as “mom and pop” grocery stores to large regional shopping centers.

Compatible (i.e. – compatible design) - Compatible design(s) do not seek to imitate the architecture but to reflect the surroundings in terms of design concepts – mass, scale, rhythm, color, materials, and building arrangement. Compatible designs will be in harmony (i.e. a combination of different but related parts to create similarities and consistency of architectural elements) with designs of surrounding developments.

Fencing, Open – Fencing design which results in a physical barrier but does not completely obscure visibility. Open fences containing regular breaks which produce a “see-through” effect, either within or between sections of the fence.

Fencing, Closed – A fence which produces a physical and visual barrier, typically used to provide security between properties.

Major Façade Improvements – Improvements to a free-standing building or group of buildings with multiple tenants that alters more than 50% of the façade (elevation) facing the public street. For example, a free standing building or group of buildings with multiple tenants that are architecturally altered (not including colors). If a building is only adding some new architectural elements or design (such as change in materials, change in roof, change in adding or removing architecture) that is less than (or equal to) 50% of the façade (elevation) facing the public street then it would not be considered major. The 50% is measured by comparing the square footage of the façade area that is changing on the building or group of buildings with multiple tenants compared to what is existing/remaining.

Multi-disciplinary design team – A group of individuals with professional expertise in the creation of built environments, including but not limited to those schooled in the fields of architecture, landscape architecture, art, engineering, environmental protection, management, and urban design.

Nonconforming lot – Parcels of land which lawfully existed as lots on the effective date of the City’s Zoning Ordinance but which do not conform to the current lot area and/or lot dimension standards for the zone in which they are located.

Objective Design Standard - a design standard that involves no personal or subjective judgment by a public official and is uniformly verifiable by reference to an

external and uniform benchmark or criterion available and knowable by both the development applicant or proponent and the public official before submittal of an application (per Senate Bill 330 (SB 330 - Section 66300(a)(7)).

Old Town – The area in the general vicinity of H Street and Ocean Avenue identified on the City Zoning Map as the Downtown Overlay District.

Open Space, Common – Open Space areas shared in common with the residential community/public. This can include but not limited to landscaping areas such as fields, gardens, and activity areas such as sports courts, BBQ areas, playgrounds.

Open Space, Private – Open Space areas that are private to the tenant or property owner (not available to the public). This can include but not limited to landscaping areas, gardens, decks, and balconies.

Street furniture- Benches, planters, trash receptacles, light fixtures, newspaper racks, etc., placed in the public right-of-way for the use of the community.

Temporary building or structures – Miscellaneous structures set without foundations, such as sheds, canopies, or fences used for the protection of the public.

Water Features- Decorative elements for outdoor areas including but not limited to fountains, reflecting pools, fish ponds, and manmade streams.

VIII. References

Development and other projects subject to architectural review must also comply with the other applicable local, state, and federal laws. Some of these are referenced below for your convenience. Copies of the Lompoc City Code Sections shown below are available online at: [City of Lompoc, CA Zoning \(ecode360.com\)](http://ecode360.com).

California Building Code, LCC § 15

Environmental Review, California Public Resources Code §§ 21000-21189.91 and CEQA Guidelines 15000-15387 with Appendices A-N

California Fire Code

Streets and Street Improvements, LCC §§ 12.12.010-12.28.080

Subdivision, California Government Code §§ 66410-66499.58 and LCC §§ 16.01-16.44.080

Trees, LCC § 12.32

Zoning Code

Residential Zones, LCC § 17.208

Commercial Zones, LCC § 17.212

Industrial Zones, LCC § 17.216

Other Zones, LCC § 17.220

Overlay Zones, LCC § 17.224

General Site and Development Standards, LCC § 17.304

Parking Standards, LCC § 17.308

Landscape and Screening, LCC § 17.312

Specific to Use Standards, LCC § 17.404

Architectural Design & Site Development Review, LCC § 17.512

IX. Ordinance

ORDINANCE NO. 1405 (95)

AN ORDINANCE OF THE CITY OF LOMPOC AMENDING ARTICLE 1 OF CHAPTER 2 OF TITLE 3 OF CHAPTER 50 OF THE LOMPOC CITY CODE PERTAINING TO ARCHITECTURAL REVIEW

THE CITY COUNCIL OF THE CITY OF LOMPOC DOES HEREBY ORDAIN AS FOLLOWS:

SECTION 1. Article 1 of Chapter 2 of Title 3 of Chapter 50 of the Lompoc City Code is hereby amended to read as follows:

"Title 3.

Chapter 2.

Article 1. Architectural Review.

Section 8825. Purpose.

The purpose of Architectural Review is to determine compliance with provisions of the technical codes and development policies of the City and consistency with the established Architectural Review Guidelines. Additionally, architectural review is intended to promote an aesthetically and environmentally pleasing and economically viable community.

Section 8826. Architectural Review Required.

A. All applications for permits for the construction of any building, structure, or sign in all zoning districts, with the following exception, shall be reviewed for consistency with the architectural guidelines. This Article does not apply to single family homes in R-1 Districts which are not part of a parcel map or subdivision map.

B. All applications for architectural review shall be made on the forms specified and accompanied by the information required by the application. The application shall include building elevations, site and landscaping plans, renderings of signs, and other information necessary to determine consistency with the architectural guidelines.

Section 8826.1 Project Approval.

A. Except as provided in subsections B and C of this Section, the required review shall be conducted by the City Planner and shall include the recommendations of other City Divisions and Departments, as necessary, resulting in a project which is approved, conditionally approved, or disapproved.

B. The Planning Commission shall perform the required review and render a decision concerning the architectural review function:

1. on all major projects which are located on parcels or lots with frontage on Ocean Avenue, Central Avenue, and "H" Street north of Cypress Avenue;
2. on major commercial and industrial projects on "A" Street north of Cypress Avenue; and
3. on all projects involving the designated landmarks and historical structures and places referred to in the 1988 City of Lompoc Cultural Resources Study, a copy of *which* is on file in the Office of the City Clerk.

B. The City Planner may refer, with or without recommendation, any application for architectural review directly to the Planning Commission for decision.

Section 8827. Processing Time.

All applications properly received and determined to be complete for processing in accordance with California Government Code Sections 65940 et seq. shall be reviewed within the following time periods:

A. Projects which are acted upon by the City Planner shall be approved, conditionally approved, or disapproved within ten (10) working days of the date of receipt of a complete application.

B. Projects which are acted upon by the Planning Commission shall be approved, conditionally approved, or disapproved within thirty (30) working days of the date of receipt of a complete application and after consideration by the Planning Commission during a regularly scheduled meeting.

Section 8828. Adoption of Architectural Review Guidelines.

A. The Council specifically finds and determines that the Lompoc Valley's natural beauty and history render the aesthetic quality of the City an important economic asset, and City design standards and other City rules, regulations, and standards relating to aesthetics and overall appearance of property are designed to protect that asset and conserve property values within the City.

B. The City Council declares and adopts the following policies relating to all development and design within the City:

1. Protection of the quality of life of the residents of Lompoc by use of designs that preserve and enhance privacy and minimize detrimental conditions such as noise, glare, unattractive uses, and unsightly elements is required for all projects.

2. Development of residential neighborhoods to preserve unity of character, unique features, and natural conditions to advance toward the goal of neighborhoods harmonious with others and of new residences compatible with existing homes and with the neighborhood is required for all projects subject to this Article.

3. Protection and preservation of the following are encouraged on all projects to the extent feasible:

Protection and preservation of the following are encouraged on all projects to the extent feasible:

- a. views;
- b. open space;
- c. historically significant sites and structures; and
- d. privately owned public art on private property.

C. The adoption of this Ordinance is specifically intended also to adopt the "Architectural Review Guidelines" (April 1995 Edition) relating to all design and development within the City of Lompoc. A copy of the "Architectural Review Guidelines" is on file in the Office of the City Clerk.

D. In determining whether to approve, conditionally approve, or disapprove architectural plans, drawings, or sketches, the Planning Commission, City Planner, and Community Services Department staff shall follow and carry out the architectural and landscaping guidelines adopted by the City Council.

E. It shall be unlawful for any person to carry out any project subject to this Article without compliance with all applicable landscape and design standards, project conditions of approval, and all laws and regulations applicable thereto.

Section 8829. Appeal to Planning Commission.

If the applicant or any interested person is aggrieved by the decision of the City Planner, an appeal in writing, together with the appropriate appeal fee as set by City Council Resolution, shall be submitted to the Planning Commission within ten (10) days following the date of decision by the City Planner. The Planning Commission, within thirty (30) days following the filing of an appeal, shall affirm, modify, or reverse the decision of the City Planner. Failure to act within the prescribed time shall be deemed to affirm the City Planner's decision.

Section 8830. Appeal to City Council.

If the applicant, any interested person, or the City Planner is aggrieved by the decision of the Planning Commission, an appeal in writing, together with the appropriate appeal fee as set by City Council Resolution, shall be submitted to the City Council within ten (10) days following the date of decision by the Planning Commission. Appeals shall be processed in accordance with Chapter 1, Sections 0133.C and 0133.D of the Lompoc City Code.

Section 8831, Approval as Prerequisite to Issuance of Permit.

No permit for the construction of any building or structure subject to this Article shall be issued until the architectural plans, drawings, or sketches have been approved by the City Planner, Planning Commission, or City Council. All buildings, structures, and grounds shall be developed in strict conformance with the approved architectural plans, drawings, or sketches. The City Planner may require the applicant to post sufficient security, in a form approved by the City Attorney, to insure the applicant's faithful performance of the approved project.

Section 8832. Revocation of Permit.

The Planning Commission may, after a public hearing with notice to the permittee, revoke any approval given pursuant to this Article, for noncompliance with any of the conditions imposed through the approval process. Such revocation shall constitute revocation of the permit. Written notice of intention to revoke shall be mailed to the permittee not less than thirty (30) days before the Planning Commission hearing date. Revocation may be appealed in the manner provided in Section 8830.

Section 8835. Lapse of Approval,

Architectural review approval is conditioned upon the rights or privileges acquired thereby being utilized within one year after the effective date of approval. Should the approved project not be so commenced and diligently pursued to completion, approval shall automatically lapse, except that if performance has been delayed by the City in approving plans, the City Planner shall grant and record a commensurate extension. The City Planner may, upon request of the permittee, for cause, grant a reasonable extension of time in addition to the one-year period. Requests for extension

Ordinance No. 1405(95)
Page 4

shall be filed with the City Planner fifteen (15) days prior to expiration of architectural review approval."

SECTION 2. This Ordinance shall be effective thirty (30) days after its adoption.

PASSED AND ADOPTED this 19th day of September 1995, by the following electronic vote:

AYES:	Councilmember:	Mary Leach, Will Schuyler, Michael Siminski George Stillman, Mayor Joyce Howerton.
NOES:	Councilmember:	None.
ABSENT:	Councilmember:	None.
ABSTAINED:	Councilmember:	None.

ATTEST:

Maureen Bosking, City Clerk
City of Lompoc

CERTIFICATE OF ADOPTION

State of California
County of Santa Barbara) ss City of Lompoc

I, MAUREEN BOSKING, the duly appointed City Clerk of the City of Lompoc, California, do hereby certify that the foregoing Ordinance No. 1405(95) was introduced at a regular meeting of the City Council of the City of Lompoc, California, held on the 5th day of September, 19 95, and was at a regular meeting of said City Council, held on the 19th day of September 19 95, by the following vote, to-wit:

AYES:	Councilmember:	<u>Mary Leach, Will Schuyler, Michael Siminski</u>
		<u>George Stillman, Mayor Joyce Howerton.</u>
NOES:	Councilmember:	<u>None.</u>
ABSENT:	Councilmember:	<u>None.</u>
ABSTAINED:	Councilmember:	<u>None.</u>

That said Ordinance No. 1405(95) was then and there declared adopted and has been signed by the Mayor and attested by the Clerk of said City of Lompoc.

IN WITNESS WHEREOF, I have hereunto set my hand and affixed the official seal of the City of Lompoc, this 19th day of September, 19 95, at Lompoc, California.

I declare under penalty of perjury that the foregoing is true and correct.

S E A L

Maureen Bosking, CMC, City Clerk
City of Lompoc, California

ARCHITECTURAL REVIEW GUIDELINES

CITY OF LOMPOC



Adopted September 19, 1995
Ordinance No. 1405 (95)

Amended June 5, 2001
Ordinance No. 1462 (01)

Amended December 17, 2019
Ordinance No. 1670 (19)

Amended March 2, 2021
Ordinance No. 1679 (21)

Prepared by:
City of Lompoc 1995 Planning Commission

Janice Keller, Chair
Kendra Beck, Commissioner
Marion "Butch" Browder, Commissioner
Ralph Harman, Commissioner
Suzie Hearrell, Commissioner

Revised by:
City of Lompoc 2001 Planning Commission

Jack Rodenhi, Chair
Ronald Fink, Commissioner
Ralph Harman, Commissioner
Ann W. Ruhge, Commissioner
Peter "Ed" Shoemaker, Commissioner

Revised by:
City of Lompoc 2019 Planning Commission

Nicholas Gonzales, Chair
Federico Cioni, Commissioner
Steve Bridge, Commissioner
Sasha Keller, Commissioner
Ken Ostini, Commissioner

Revised by:
City of Lompoc 2021 Planning Commission

Federico Cioni, Chair
Steve Bridge, Commissioner
Sasha Keller, Commissioner
Ken Ostini, Commissioner

I.	OVERVIEW	7
	A. Why This Book?	7
	B. Who Does the Reviewing and What is Reviewed?.....	8
	1. Minor Architectural Design and Site Development Review.....	8
	2. Major Architectural Design and Site Development Review.....	8
II.	ENFORCEMENT	9
III.	ARCHITECTURAL CHARACTER/BUILDING DESIGN	9
	A. Neighborhood Compatibilities.....	9
	B. Residential – Infill	14
	C. Views and Obstructions	15
	D. Exterior Colors	18
	E. Materials	19
	F. Lighting.....	19
	1. Exterior Lighting-Residential	19
	2. Exterior Lighting-Commercial Industrial	21
	G. Accessory Equipment	22
	H. Awnings	24
IV.	SITE DESIGN	26
	A. Landscaping and Open Space	26
	1. Trees and Vegetation	26
	2. Plazas and Courtyard	27
	3. Open Space-Multi-Family	27
	4. Decks.....	27
	B. Parking.....	28
	C. Fences and Walls	29
	D. Signs.....	31
	E. Commercial	31
	F. Industrial.....	32
V.	ADDITIONAL GUIDELINES FOR SPECIFIC ZONES.....	32
	A. Public Facility	32
	B. Mixed Use	32
VI.	ADDITIONAL GUIDELINES FOR SPECIAL DISTRICTS AND SITES	33
	A. Old Town	33
	1. Purpose.....	33
	2. Organization	35
	3. Interpretation	35
	4. Applicability	36
	5. Exemptions.....	36

6. Context & Compatibility	37
7. Design Criteria	39
a. Infill	39
i. Façade Proportion	39
ii. Proportion of Openings	40
iii. Horizontal Rhythms.....	41
iv. Wall Articulation	41
v. Roofs.....	43
vi. Building Material Palette.....	43
vii. Mechanical Equipment Screening	44
viii. Setbacks and "Build To" Lines.....	45
ix. Street Orientation	45
x. Parking Lot Orientation	46
b. Storefront Design	48
i. Entries/Doorways	48
ii. Facade Color	48
iii. Awnings and Canopies	48
iv. Door and Window Design.....	49
v. Rear Entrances.....	50
vi. Window Replacement	51
vii. Door Replacement	52
viii. Removal of Existing Canopies and Metal Awnings.....	52
ix. Removal of Elements Inconsistent with Original Façade .	52
x. Preserve Traditional Decoration.....	53
xi. Selection of Building Materials	53
8. Signs.....	54
a. An effectively designed sign should	54
b. Preferred Sign Types	54
c. General Design Guidelines.....	55
i. Clear Sign Message	55
ii. Sign Color	56
iii. Sign Architectural Compatibility	57
iv. Wall Mounted Signs	58
v. Awning Signs	59
vi. Banner Sign	60
vii. Hanging Sign.....	60
viii. Window Sign	61
ix. A-Frame and Portable Signs	62
x. Freestanding Signs	63

9. Landscaping & Public Spaces	63
a.Introduction.....	63
b.General Landscape Design Guidelines.....	63
c.Public Spaces	65
i.Plazas.....	65
ii.Entry Courtyards	67
iii.Public Art	68
10.Designing for Crime Prevention.....	68
a.Design Considerations	69
11.Secretary of the Interior’s Standards for Rehabilitation	72
B. Airport.....	73
VII. GLOSSARY	74
VIII. BIBLIOGRAPHY	75
IX. ORDINANCE	76

This page intentionally left blank.

I. OVERVIEW

Architectural review is one of several procedures the City uses to guide development in the interest of the public's health, safety and general welfare. It was created by local ordinance to be separate from, and in addition to, other approvals (such as a use permit, rezoning or a building permit) which might be required for a project. Although architectural review of some projects is done by the Planning Commission, City Planning staff handles architectural review for the majority of projects within the City.

Architectural review is a process to review development before something is built or modified. The process may look at more than building design. It also examines a project's layout with its relationship to the neighborhood as well as the effect the development will have on the overall quality of life in Lompoc, and all factors in a project's appearance. Some of these factors may be considered separately by the City's Planning Commission as part of a use permit, for example, but they must also be considered as part of a complete architectural picture.

Architectural review, more than any of the City's other development review procedures, involves subjective judgments. However, those judgments are not arbitrary. They are based on recognized principles of design, planning, and aesthetics, and they follow a written policy and a set of guidelines.

The City encourages creative design, new ideas in the use of building materials, and innovative construction methods, as long as what is proposed falls within the City's guidelines. Yet, while encouraging creativity, the City also tries to be sure there is worthwhile purpose behind innovation. The goal of architectural review is development that not only is well designed, but also "fits" in Lompoc, with projects that strike a balance between the developer's preference and the public interest.

A. Why This Book?

Applying the City's principles to complex construction projects can be a long process. That is why the City prepared this booklet: to explain why the City requires architectural review, what are the benefits, how it works, and to provide clearer standards which will improve and quicken the architectural review process.

B. Who Does the Reviewing and What is Reviewed?

Architectural Design and Site Development Review shall be required for all new buildings or structures and additions and alterations to existing structures with the following exceptions:

- A. Single-family homes in R-1 zones, and development projects with six (6) or fewer residential units in the R-2, R-3, and MU zones, that are not part of a subdivision map.
- B. Accessory dwelling units;
- C. Additions of floor area within the existing building envelope;
- D. Additions and alterations to existing buildings and structures that will not increase the gross floor area of the building by more than 2,500 square feet and will not involve exterior alterations along any street-facing façade on Ocean Avenue, H Street (north of Cypress Avenue), or Central Avenue; and
- E. Alterations and improvements required to meet Federal or State requirements to accommodate persons with disabilities.

An application for an Architectural Design and Site Development Review shall be prepared, filed, and processed in compliance with Chapter 17.5-04 (Application Processing Procedures). The Review Authority for an Architectural Design and Site Development Review shall be as follows:

1. Minor Architectural Design and Site Development Review.

All projects that do not meet the criteria for Commission review as specified below and are not exempt (17.512.020) shall be subject to review and approval or denial by the Director.

2. Major Architectural Design and Site Development Review.

The Commission shall be the Review Authority for any of the following:

- a. New construction of more than 2,500 square feet of gross floor area or new additions of more than 2,500 square feet of gross floor area; or
- b. New construction with frontage on Ocean Avenue, H Street North of Cypress Avenue, or Central Avenue (excluding additions); or
- c. Any major façade improvements with frontage on Ocean Avenue, H Street (north of Cypress Avenue), or Central Avenue. (Ord No. 1679 (21))

II. ENFORCEMENT

All requirements of these Architectural Review Guidelines shall be enforced by City staff. Enforcement shall be carried out in the manner prescribed by State law.

III. ARCHITECTURAL CHARACTER/BUILDING DESIGN

A. Neighborhood Compatibilities

A neighborhood is primarily defined as that area of the City that is visually impacted by the proposed building project. This normally will include the street frontage between adjacent cross streets, properties along that frontage, and properties located within the same block as the building project.

1. Each phase of a phased development shall attain a visual completeness. Temporary barriers/walls should be painted and trimmed to integrate with the permanent construction.
2. Visual bulk should be minimized through the use of creative site planning on small sites with minimum setback requirements and proportionally large dwellings.
3. For new residential developments a minimum of five different street frontage designs, not including mirror images, should be provided. A particular street frontage design, including its mirror image, should not appear more often than every fourth house.

4. Housing types may be mixed within each new subdivision (i.e., duplexes and townhouses can easily and effectively exist in the same neighborhood as single-family homes).
5. On previously undeveloped land, architecture should be compatible with surrounding natural features.
6. All proposed buildings or structures should be sensitive to the neighborhood character.
7. Design elements should be used that are consistent with the existing style.
8. Entry to garages should be incorporated into the architecture of the dwelling to minimize visual prominence.
9. The construction of multi-story buildings or additions in predominantly single-story neighborhoods can be compatible provided the design incorporates features, which reduce the visual prominence of the second floor. Design features which generally reduce visual prominence include:
 - a. Avoidance of continuous horizontal trim between floors;
 - b. Provision of second floor offsets to avoid an unrelieved two-story wall;
 - c. Placing the second floor towards the back of the house to avoid a two-story profile at the street; and
 - d. Placing the second floor in the middle of the footprint to provide a one-story transition to adjacent homes.

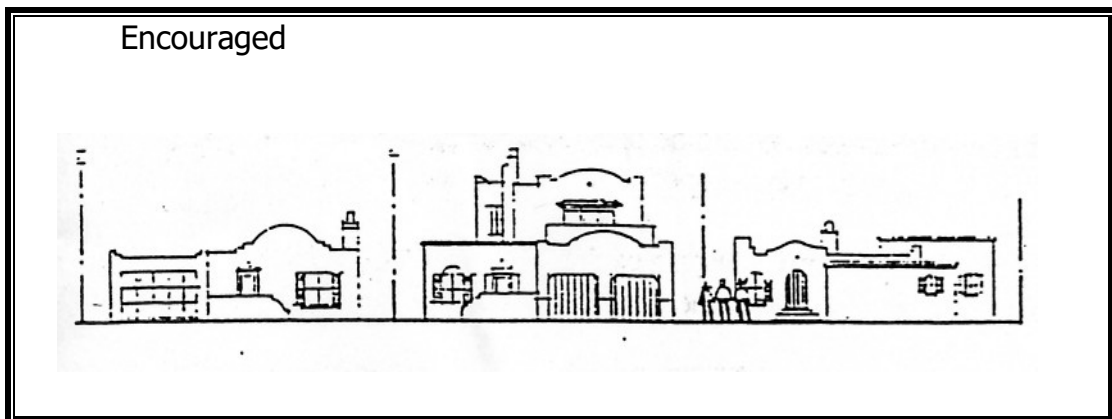

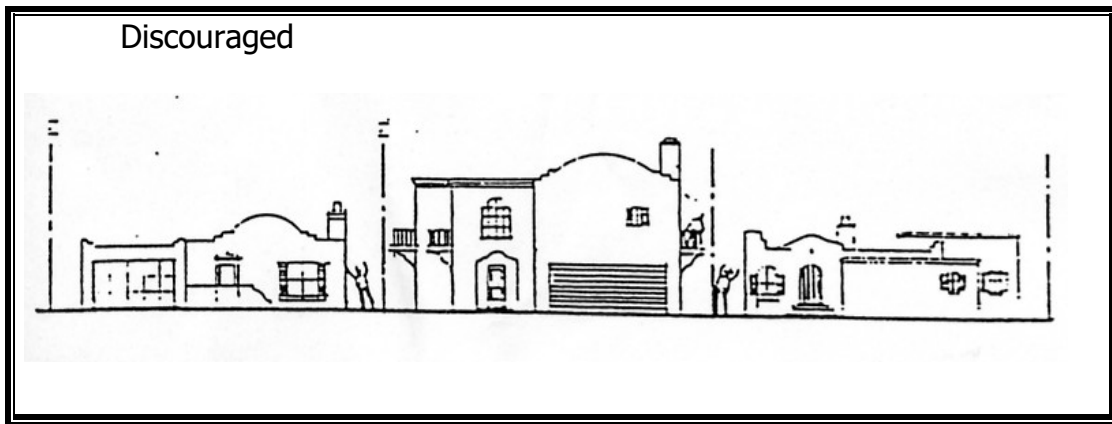

10. Multiple buildings on the same site shall be designed to create a strong visual relationship between the buildings with subtle variety in building size and mass.
11. Buildings shall achieve a human scale and interest. Wall insets, balconies and window projections, etc, are examples of building elements, which may help reduce the scale of larger buildings.
12. A transition from low buildings on the street frontages to larger and taller structures on the interior of the project is generally encouraged.
13. All buildings elevations visible to the public shall be designed and architecturally treated. The choice of materials, colors, and the level of detailing shall be thoughtfully integrated into the design. All elevations need not look alike; however, a sense of overall architectural continuity is encouraged.
14. Code-required elements, such as parapet walls and screen walls, shall be treated as an integral part of the architecture and these elements shall not visually weaken the design.
15. Building entries shall be protected from the elements and should create a sense of entry of focal point for the structure.
16. Architectural/design standards for temporary buildings or structures shall be generally the same as for the permanent buildings.
17. Building forms should follow hillside contours as means to improve building/site integration.

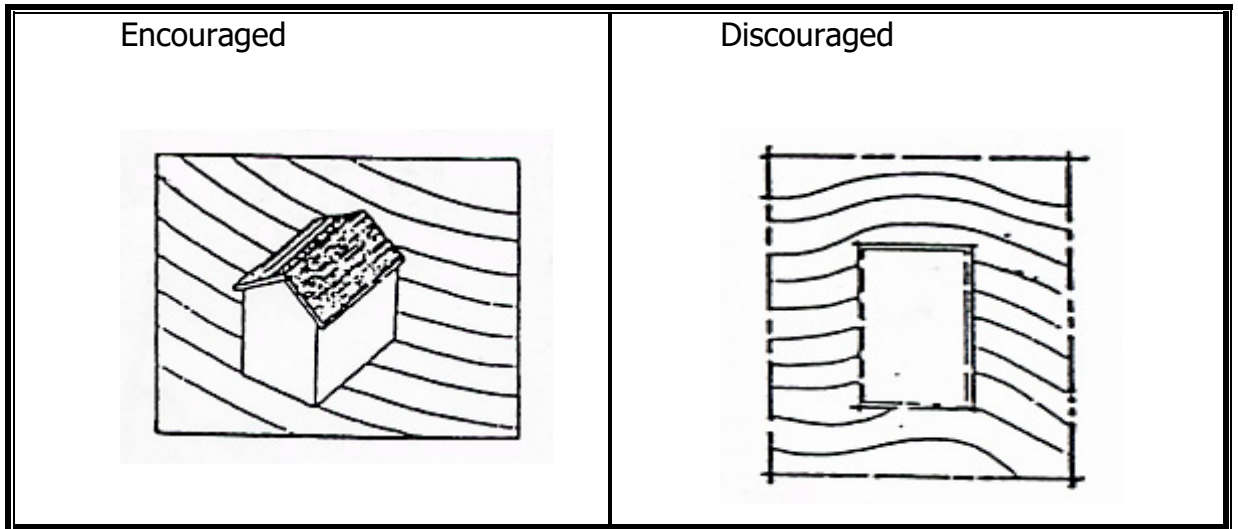
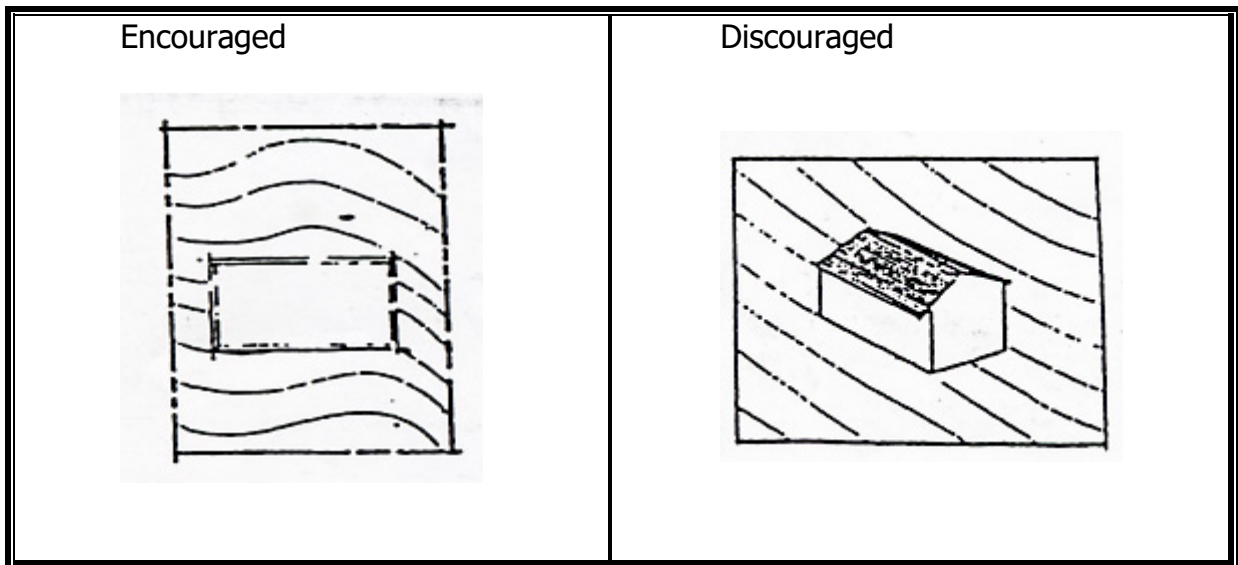

18. The use of energy-saving design techniques, such as proper sun orientation, shade trees, overhangs, earth berms, and window placement is encouraged.
19. Exposed rooftops shall be treated as visually sensitive areas. Rooftop mechanical equipment is not prohibited, but its design and screening must be incorporated in the building design so as not to appear cluttered.

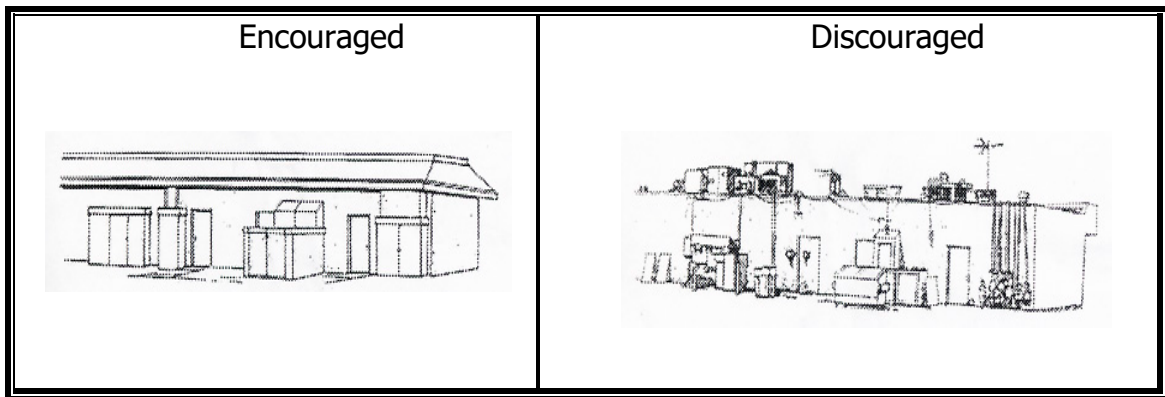

20. The ground floor levels of buildings where pedestrian activity is high shall include elements of visual interest to pedestrians. Display windows, retail shops, and courtyard entrances are encouraged.

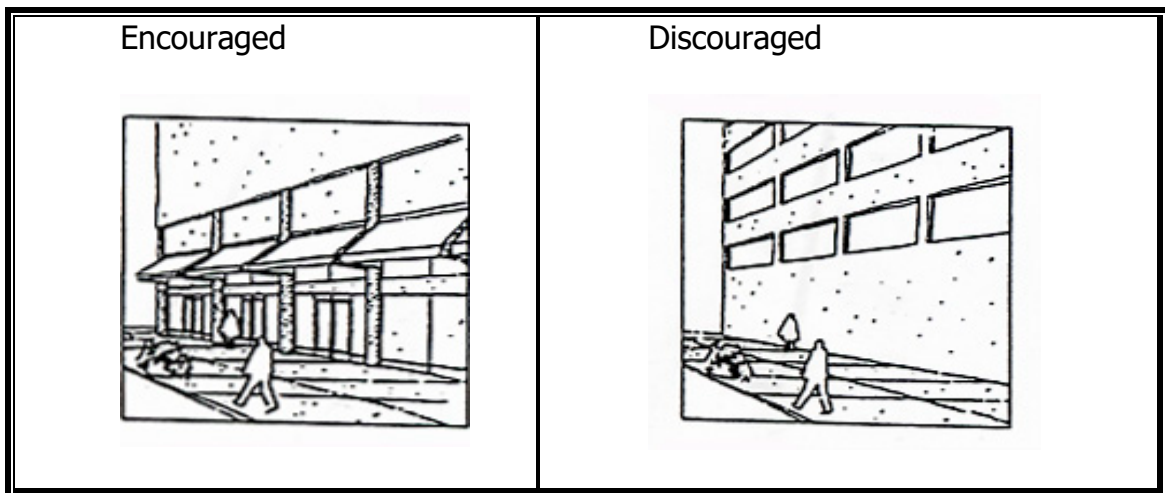

21. Uses which visually disrupt the continuity of pedestrian movement (such as open parking lots, parking structures, backs of buildings, or delivery areas of buildings) should be designed to “bridge” the active areas.
22. Large paved areas should be avoided. Paved areas should be broken up by using colored materials and/or landscaping.
23. A unified theme should be incorporated into each commercial center. Additions and alterations must be consistent with and enhance the design theme.

B. Residential – Infill

This section applies to additions, remodels and new infill construction of four dwelling units or fewer. These guidelines are in addition to those set forth elsewhere in these Architectural Review Guidelines.

1. Structures should be designed to harmonize with the existing neighborhood and with the existing on-site structures. New buildings should be compatible with the neighboring houses in terms of proportion, size, mass, and height. Architectural style is not restricted to those in the existing neighborhood, but should be compatible.

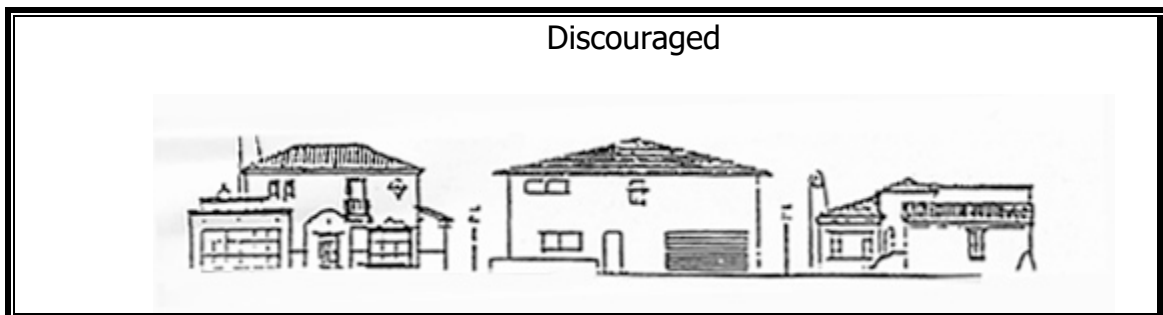
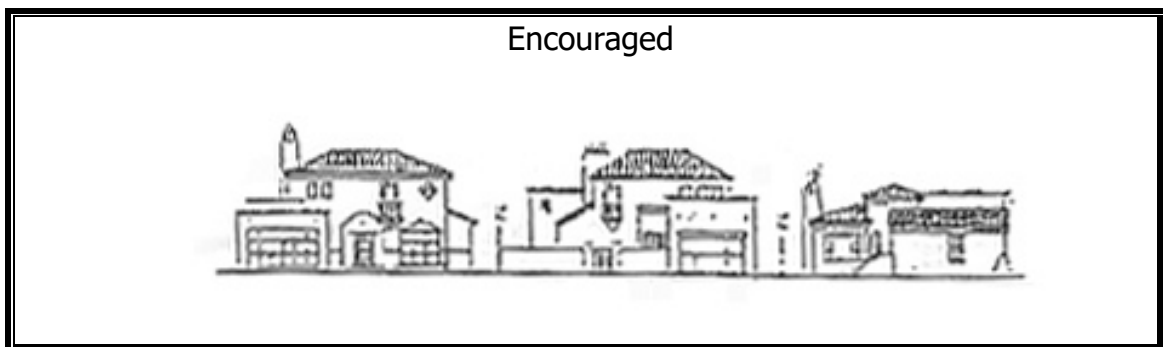

2. Materials and colors that are compatible with the neighborhood should be selected.
3. The height of the building elements should be varied.
4. Higher portions of structures should be set back from the lot lines to reduce the appearance of height.
5. Architectural features should be used to break up unacceptable bulk, such as varying rooflines, using combinations of vertical and horizontal elements, creating patterns with doors and windows, and using recessed and projecting spaces to create interest.

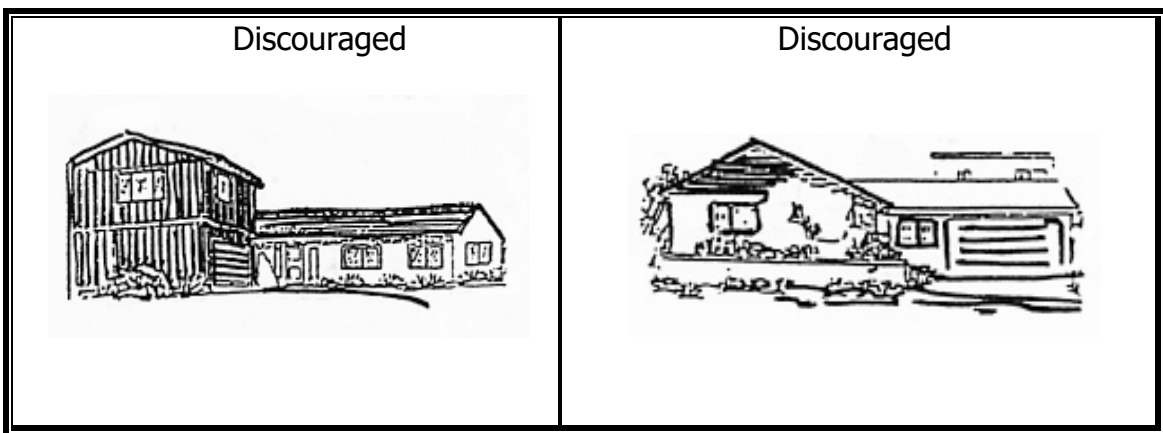
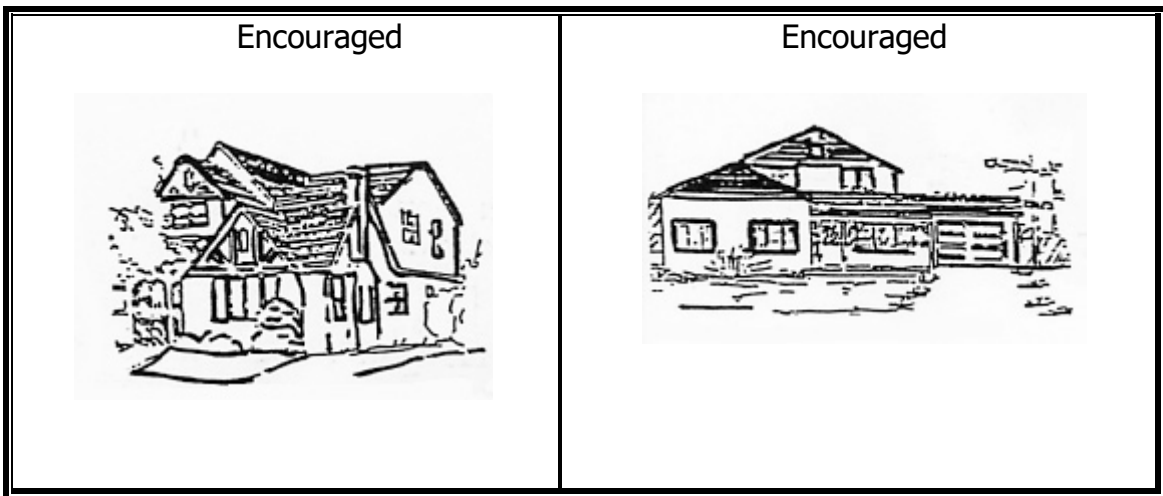

C. Views and Obstructions

1. Obstruction of views should be minimized through reduction in the height of the structure, location of the higher portion of the structure so as to minimize the adverse impact, and the avoidance of tall landscaping.

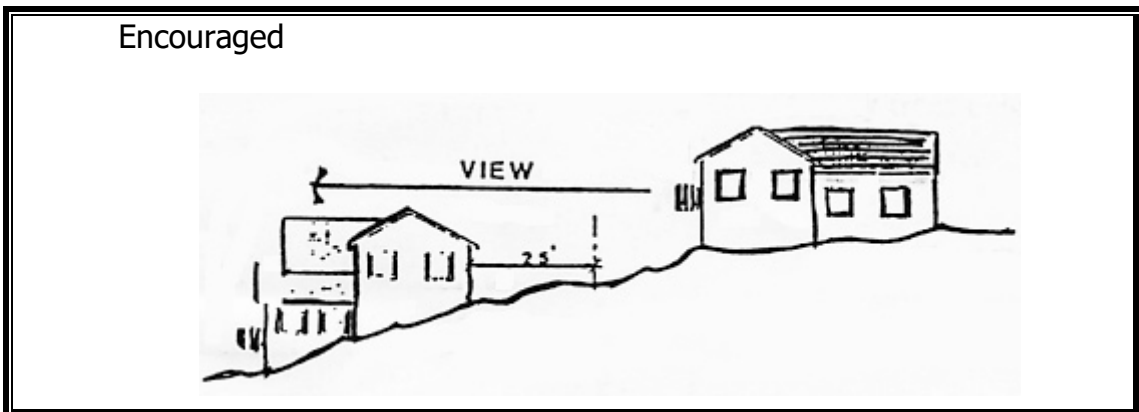

Discouraged

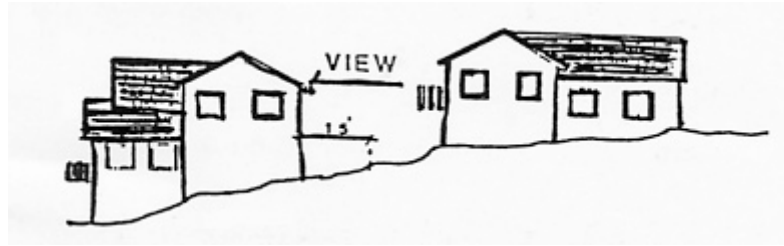

Encouraged

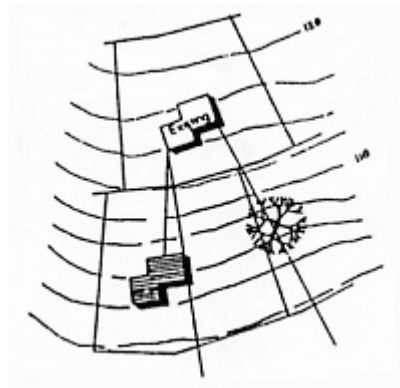

Encouraged

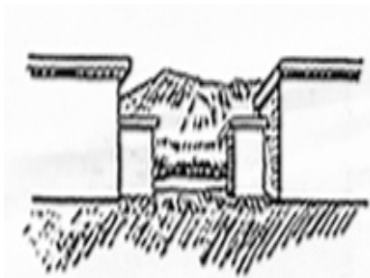

Discouraged

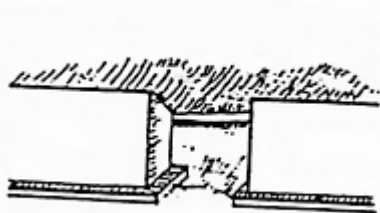

Discouraged



2. Protection and perpetuation of panoramic views from various parks and public places within the City is encouraged.
3. Surrounding ridge-tops should be preserved. The tops of structures in hillside development should be below the skyline as perceived from the nearest arterial or collector street.

4. Consideration of sensitivity to potential neighbors' views in the placement and architectural appearance of the house is encouraged.
5. Views from major living areas should be protected.
6. Adverse impacts on views may be approved if alternative design treatments meeting the standard are not feasible.
7. Housing design should encourage the possibility of community interaction while affording privacy. Privacy within each unit and its immediate outdoor space should be carefully maintained, but an effort should be made through the placement of units to allow a natural public space pathway for interaction. The protection of privacy of adjacent residents should be a major design consideration.
 - Structure and additions should be located to increase visual distance between buildings.
 - Upper floor balconies should be oriented toward the yard area.
 - Windows in adjacent homes should be offset from one another.
 - Translucent or high windows should be used to allow illumination while protecting privacy.
 - Areas that require more privacy should be located away from neighbors.

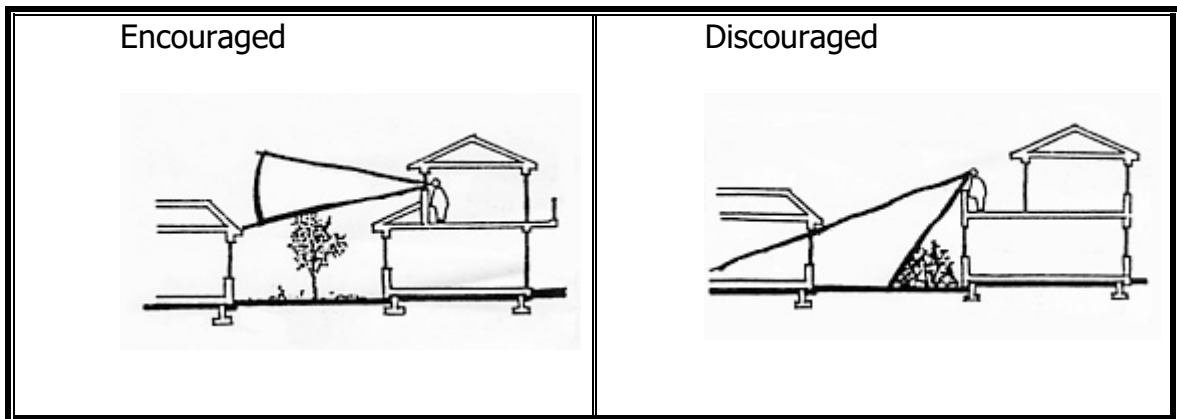

8. Active outdoor areas should be oriented away from neighbors.
9. Placing noise sources (i.e., pool or air conditioning equipment, garbage cans, parking areas, etc.) at the sides of small lots should be avoided.

10. Walls and landscaping should be used to act as noise buffers.
11. Projects should include noise attenuation measures for internal noise. Necessary noise attenuation measures shall be architecturally integrated in the building design.
12. Units should orient to the common areas whenever possible.

D. Exterior Colors

1. Colors may be varied. The colors of all elements of a development including walls, accessory structures, fences, bollards, and signs should be compatible with each other and with materials, architectural style, and details. Accent colors may be used, but should not compete or be garish.
2. Building color in built-up areas, characterized by a dominance of buildings, should be compatible and blend with surrounding buildings.
3. In commercial areas, color should be used to unify a building façade that is divided into many individual storefronts.
4. A building should be treated as consistently as possible on all sides. Color on side and rear walls should avoid harsh shifts in effect from the front or street facing walls.
5. Generally, paint should not be used to conceal brick or stone.
6. Color in historic areas and on historic buildings should be chosen with respect for the history of the area and the building. Historic color palettes based on research, old photographs, and historic records are encouraged.
7. Building color in hillside areas, characterized by a dominance of natural landscape, should emphasize a natural palette - earth tones, warm grays and greens-and allow the building to blend into the natural background.
8. A color plan showing the location of all colors on the building and color chips of colors and exterior material samples shall be submitted to the Planning Division for approval of exterior colors.

E. Materials

1. Highly reflective finishes are discouraged.
2. Metal buildings may be approved if they are well-designed and compatible with surrounding buildings.
3. Any exterior changes in materials should occur at changes in plane and at inside corners.

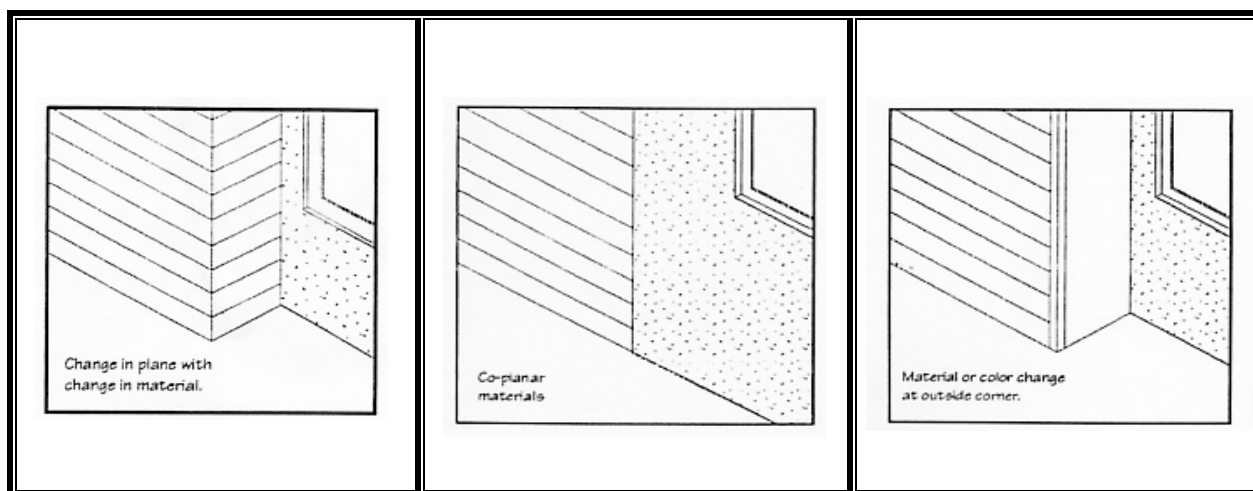

F. Lighting

Exterior lights should be architecturally compatible with the proposed project. New lights should not stand out in relationship to surrounding lights when viewed from a distance. The goal is to maintain the City's existing uniformity of lights as viewed from a distant vista or entrance into the City. These lighting guidelines are not intended to limit or otherwise restrict security or safe lighting practice.

1. Exterior Lighting-Residential

- a. Lighting should be subdued and utilized to provide enough illumination for safe access to the residence.

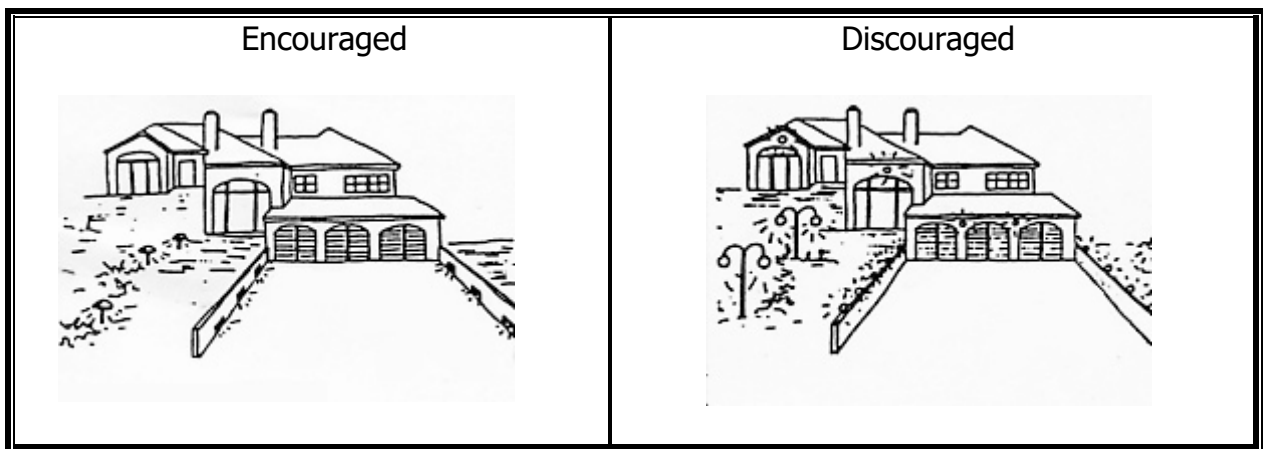

- b. All site, landscape or building exterior lighting should be of a configuration, style and finish color that compliments the theme and materials established by the building architecture.
- c. All exterior lighting should be adequately controlled and/or shielded to prevent glare and undesirable illumination of adjacent properties and streets.
- d. Bare bulb light fixtures such as flood and spotlights are not permitted in any area subject to the public view.

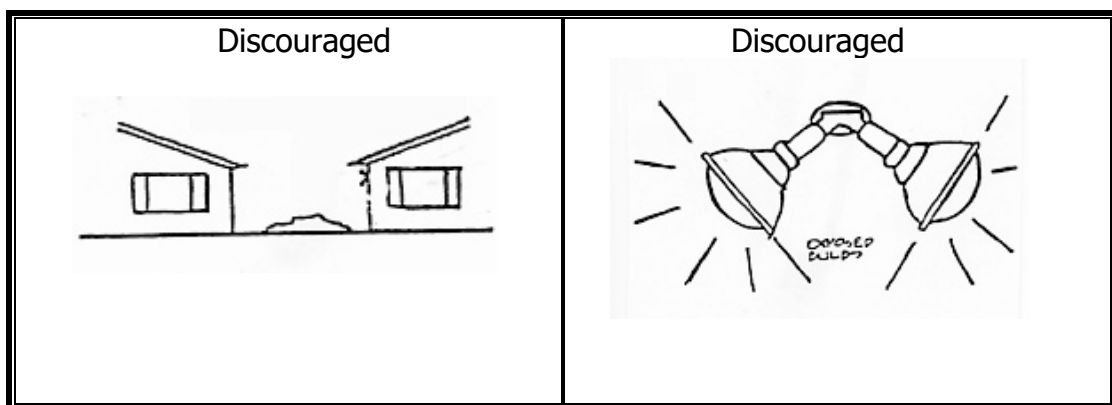
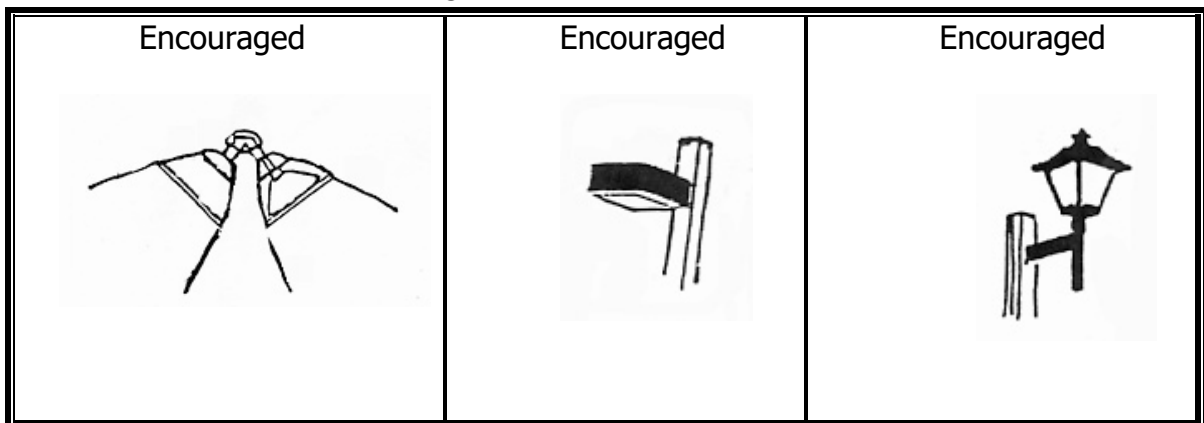

- e. Clear glass lanterns, carriage lamps, globes and other similar decorative lamps will be permitted at the front and rear of a residence in the required yard setback areas provided that the light source is 75 watts or less.
- f. All side wall lighting and site lighting located in required yard setback areas shall be screened from direct view of the light source. Frosted glass, textured glass, and pebbled glass are acceptable screening materials.

2. Exterior Lighting-Commercial Industrial

In addition to all applicable aspects covered under Exterior Lighting - Residential, lighting on sites used for commercial or industrial purposes shall comply with the following.

- a. High intensity lighting fixtures for the purpose of security shall not be substituted for site or landscape lighting or general building exterior illumination. High intensity lighting shall be limited to loading and storage locations or other similar service areas. There shall be no overspill or glare across property lines or onto the street.
- b. Pole mounted fixtures rather than wall mounted light fixtures generally should be used to light perimeter parking lots. These may be located within or at the outside edges of the lot. Perimeter lights should generally be down-lights with cut-off shields or otherwise be directed toward the interior of the lot.

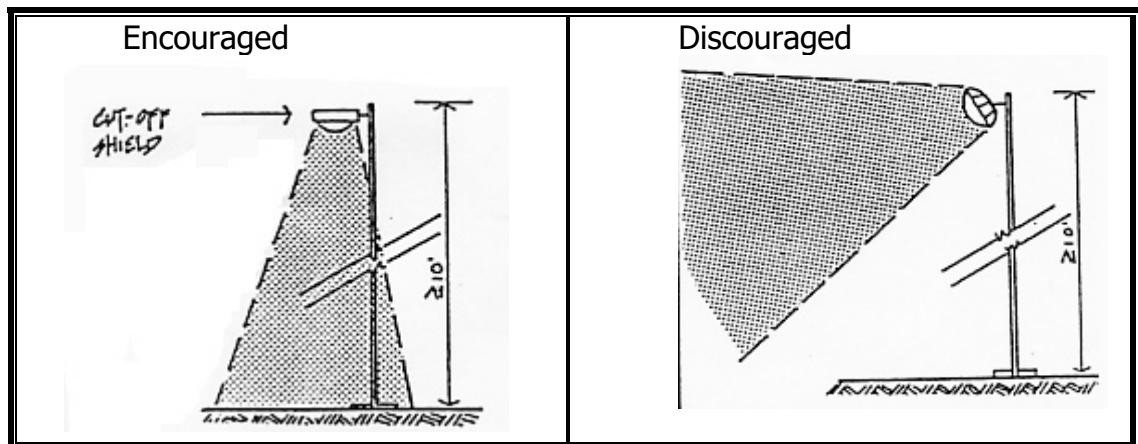

- c. The height of parking lot pole light fixtures should be compatible with the building height.
- d. Moving, flashing, rotating, twinkling and exposed neon accent lighting and wall mounted lighting that is intended to “wash” the building in a soft glow generally is discouraged, but may be used to accent architectural features.
- e. Lighting fixtures in parking garages and parking structures that are visible from the street and surrounding property shall be screened so that the light source is not visible.
- f. External signage lighting should be directed to the illumination of the sign without spillage.
- g. Lighting fixtures located at ground level should not create hazards to pedestrians along public access.
- h. The use of energy-conserving fixtures or lighting systems shall be given primary consideration in the design of the lighting program.

G. Accessory Equipment

All accessory equipment, including storage structures, mechanical equipment and electronic equipment shall be designed and placed to harmonize with the major structures on the site and with the neighborhood. The use of landscaping or other screening is encouraged.

1. Solar energy – Where solar energy is used as a primary or supplementary source of heat or other energy, solar collection devices should be mounted in a manner that preserves the property’s characteristic features. Solar collection devices not attached to the building should be located only in side or rear yards. Exposed hardware, frames, and piping shall have non-reflective finishes consistent with the color scheme of the building and/or roof.
2. Wind devices – Wind generators or other energy devices should be located in rear and side yards away from public view. Their height should be determined by the height of the principal structure. They should be painted to blend with or match the adjacent buildings or natural surroundings.

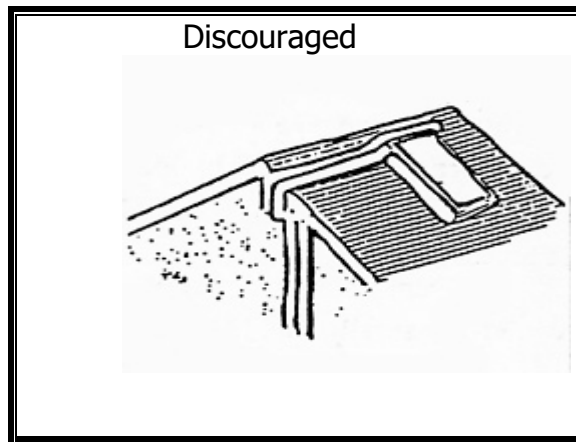
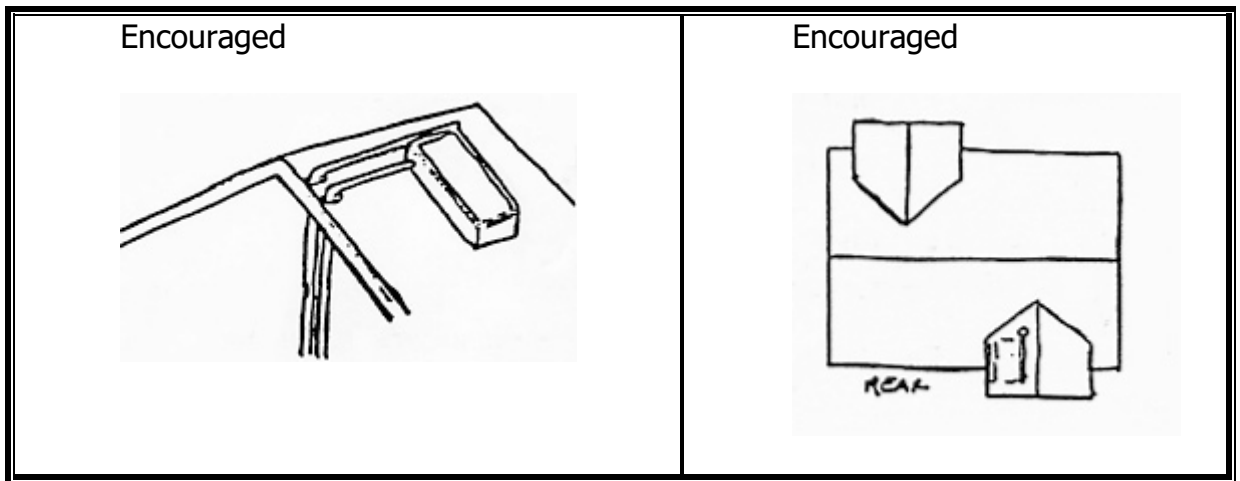

3. Other Mechanical Equipment – To minimize the impact of mechanical equipment on the appearance of the building and the community, window air-conditioning units or condenser elements shall not be located on the front facades. Antennas should be located where they are not visible from the front elevation. Mechanical equipment on the ground should be screened with the fence or plant materials or housed in a structure that harmonizes with the surroundings.
4. Instructions and identification signage, miscellaneous storage boxes, and other necessary items shall be integrated into the design of the fixture.
5. All visible projections, including but not limited to new gutters, vents, pipes, flashing, utility boxes, fire extinguisher boxes, downspouts, and chimney flues, should be kept as low as possible and covered or painted to blend with the colors of the building or roof.

6. Carports, light fixtures, fences, mailboxes, and other utility structures shall be integrated into the architecture.
7. Refuse collection areas shall be located or screened to minimize public view.

H. Awnings

1. Awnings generally should be used to provide sun and rain protection.
2. Awnings should be intended solely as a background for a sign or signs. If a sign is to be part of the awning, the sign portion shall be placed on the valance.
3. Awnings should compliment the building architecture. Awning shape, color, material, and location on the building shall be compatible with the building architecture, relate well to the dominant architectural features, and not cover up or hide handsome material or important details.
4. Awnings should not impose a new or incompatible shape or style on a building. Awnings that are intended to dramatically alter the appearance of a building will be reviewed with great caution since the building structure generally is the most important visual element, with awnings of secondary importance.
5. Awnings generally should be located to fit within window and/or door recesses.
6. Awnings generally should not extend the full length of the building façade. The building structure should clearly wrap around and visually contain the awning.
7. Awnings should not be installed under significant eave overhangs, cantilevers, or other prominent architectural projection.
8. Bright, highly saturated colors, reflective materials and brightly illuminated back lighting of transparent materials should be avoided in the awnings. The Planning Division may request documentation of color permanence from the manufacturer before approving brightly colored awnings.



9. Solid colors and/or low contrast stripe patterns generally are acceptable awning color treatments.
10. Awning colors should not be changed by painting over the awning. Rather, a new awning fabric should be used.
11. Awnings in historic areas and on historic buildings should respect the history of the area and buildings. Historic colors, styles, and mounting locations based on research, old photographs, and historic records are encouraged.
12. Uniform shape, color, and placement should be used when multiple awnings are proposed for a single building. New awnings generally should match any existing awnings on the building. Existing inconsistent awning styles on a building do not justify approval or additional or new awning styles. New awning approvals are intended to reduce the numbers of inconsistent styles.
13. An individual awning proposal for multi-tenant buildings will be evaluated to its acceptability as a model for use by all other similarly located tenants in the building. Approval of a single awning for a multi-tenant building generally establishes a precedent that encourages other awning proposals and, therefore, will be carefully considered. Such proposals may be denied if it is determined that limiting use of the awnings to the applicant's frontage disrupts building symmetry. An overall awning plan for a multi-tenant building may be required.
14. Awnings shall be maintained in good repair and in a clean and attractive condition. Torn, bent, or faded awnings shall be repaired or replaced. Awnings may be removed only with prior approval of the Planning Commission.

IV. SITE DESIGN

This section deals with site design elements besides the structure. These include existing, proposed, natural, and man-made elements.

A. Landscaping and Open Space

1. Trees and Vegetation

- a. Significant trees and vegetation shall be protected, preserved and/or replaced during site design and construction of any building, as detailed below. The applicant shall adhere to the Lompoc Tree Ordinance and Lompoc City Code Sections 12.32.050 and 12.32.060 and 15.52.010 through 15.52.060.
- b. The design and placement of all buildings should incorporate existing, healthy, and visually prominent trees into the site design. Prominent trees are those of sufficient size and health that they have significant visibility to public streets and/or make a significant contribution to the forested skyline of the city.
- c. Landscaping should be used to blend the structure with the environment.



- d. The use of ersatz materials as fulfillment of the landscape provisions is prohibited.

2. Plazas and Courtyard

- a. Outdoor areas should be refreshing, comfortable and have enclosed boundaries or a focal point.
- b. Outdoor public spaces should provide comfortable seating for conversation and places to rest.
- c. Landscaping, monuments, art work, and water elements are encouraged.
- d. Public places with defined boundaries and protection from automobile noise and fumes are encouraged.
- e. Fountains and water features should be designed to look attractive with or without water.

3. Open Space-Multi-Family

In multi-family residential units, both private and common usable open space shall be provided. Private usable open space for each dwelling unit shall be directly accessible from the unit, and shall be large enough to permit outdoor living opportunities. Common areas should be readily accessible from all buildings and integral to the on-site pedestrian system. The location of open space areas should take into account the prevailing winds and sun orientation.

4. Decks

Decks that add significant bulk to the design of a single-family dwelling should be avoided unless they are designed in a manner compatible with the structure.

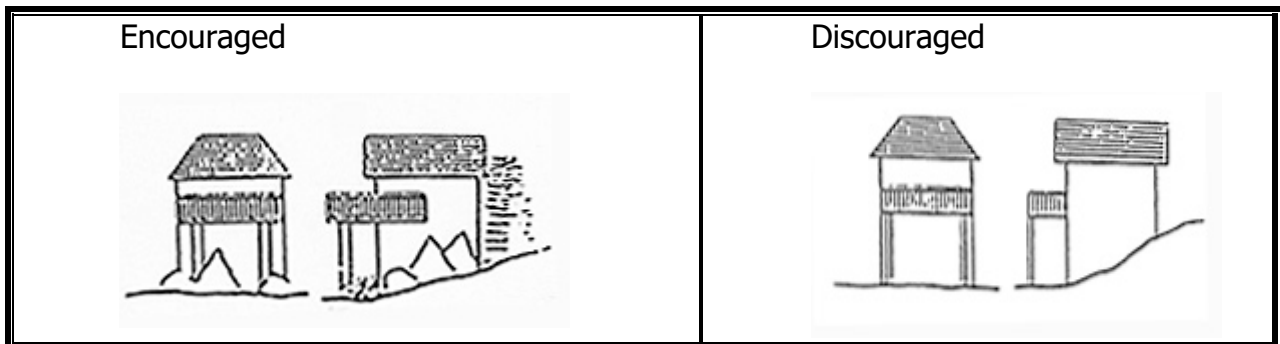

B. Parking

1. Parking lots and loading areas shall be substantially screened from adjacent streets. This may be accomplished by landscaping, fences, walls, screen structures, buildings, or combinations of any of these. All screening must be provided on site.
2. In locations where significant views of parking lots are unavoidable due to features such as driveway entry width, topography, or building orientation, visually interesting pavement and interior landscape treatments are encouraged. Pavement color, material changes, and canopy trees may be used to visually break up large expanses of pavement and provide interest.
3. Screen planting and/or structures taller than 2'6" when measured from adjacent parking lot grade generally will provide adequate visual screening. Solid and continuous screen planting or structures over 3' high can inhibit visual access. Variations in height above 3', such as those provided by occasional trees or widely spaced taller shrubs, can be used to provide both security and screening.
4. Screen planting at grade should maintain planting width to provide adequate room for effective plant growth as determined by the City's Urban Forester.

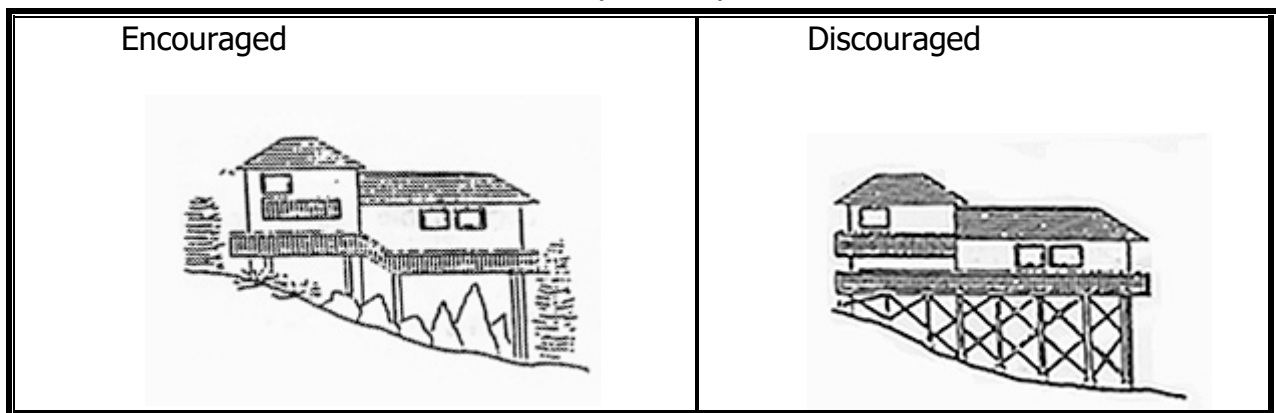

5. Planters less than three (3) feet in width at grade do not provide adequate screening; therefore, these should be used in combination with a wall, fence, raised planters, or other screen structures.
6. Landscape planting which is used for parking lot screening shall be of height and density needed to provide a positive visual barrier within two (2) years after planting.

7. Parking lot screen structures shall be visually interesting. They should be compatible in design, quality, color, and materials of the project buildings.
8. The surface areas adjacent to building walls should be softened by the use of landscaping which compliments the architectural forms of the building.
9. Long lines of parked cars and blank garage doors should be avoided; these problems can be minimized by wing walls, variations in roof design, trim, floor overhangs, building or unit offsets, window boxes, bays, balconies, trellises, chimneys, etc.
10. Driveways, carports, or open parking areas should be screened to avoid conflict of headlights with living areas.
11. Loading and parking areas should be separated.

C. Fences and Walls

In addition to the following, developers must comply with requirements of Lompoc City Code Section 17.088.150.

1. Fences and walls should be integrated with structures and setting.

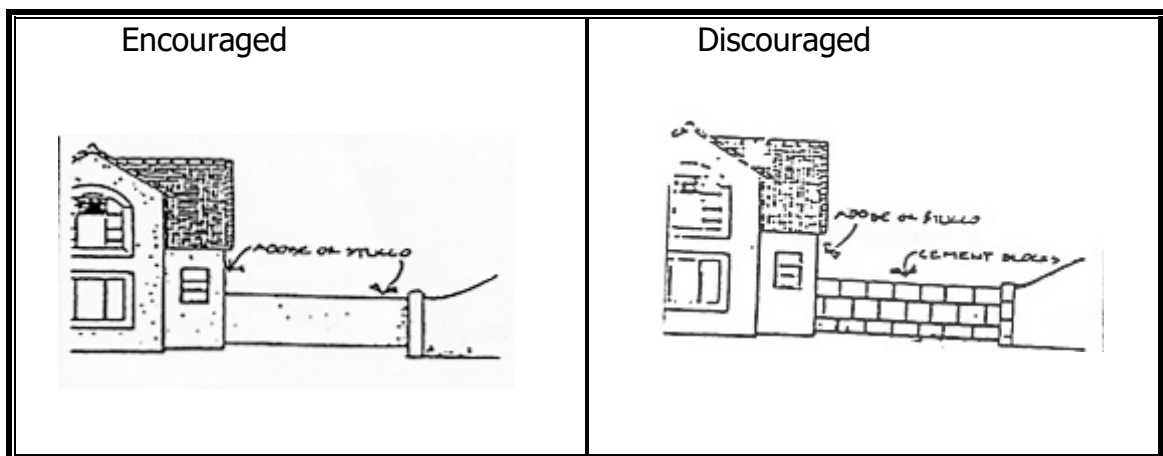

2. For fences or walls that face public areas, wood, iron, tubular steel, stone, or plant materials are preferred. Plastic, fiberglass, and plywood are not acceptable fence or wall materials.

3. Exposed foundation walls should be stone-faced, slumpstone, or exposed-aggregate concrete and as inconspicuous as possible. In general, the maximum exposure of smooth concrete should be ten inches.
4. Retaining walls should be of dry stone, stone masonry, or slumpstone block. Log and railroad ties may be used on a limited basis. Retaining walls should harmonize in design and materials with nearby structures. Retaining walls over five (5) feet high and designed in a single, uniform vertical plane with exposure to street and/or neighboring properties should be avoided. Retaining walls should be set back from property lines to allow areas for landscaping between walls and adjacent lots.
5. Retaining walls should be broken into low segments.
6. Horizontal lines and proportion should be used to reduce the perception of height and bulk.
7. Use open rather than solid fence design to reduce the visual and structural bulk.

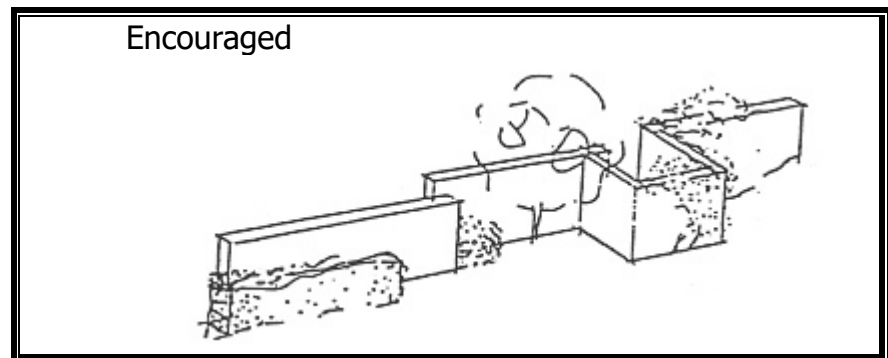

8. Earth tone colors and native, natural materials should be used.
9. Vegetation and landscaping should be integrated with fence and wall design.
10. Chain-link fence shall be softened with landscaping.
11. The appearance of the project from the street elevation is important. Perimeter fencing and/or walls that create a "walled city" effect should be avoided. If back-on street layout perimeter fencing is essential, then the design shall provide for pedestrian access through the wall.

D. Signs

In addition to the kind, size, and height standards of the Sign Ordinance (Lompoc City Code Sections 17.108.010 to 17.108.090), the following criteria apply to individual projects:

1. Signing and graphics shall bear a relationship to the overall design. Sign concept and location shall be considered and architecturally incorporated during the design of the building(s).
2. Signs shall be simple and easy to read.

E. Commercial

In addition to all guidelines set forth elsewhere these Architectural Review Guidelines, the following guidelines are applicable:

1. On larger commercial sites, a portion of the total building area should be located at the street perimeter. Such siting, together with substantial landscape treatment, reinforces and strengthens the streetscape and helps to screen off-street parking areas. However, such siting should not "enclose" the project from street view.
2. Service areas should be well-screened from pedestrian, customer, and vehicular circulation areas.
3. Commercial centers abutting residential areas shall mitigate noise and light penetration impacts, but should allow for pedestrian access.
4. Street furniture and accessories should be consistent throughout vehicular and pedestrian areas.
5. Public art is encouraged and should be appropriate to the location.
6. Loading areas should be located where they can function efficiently without detracting from the aesthetics of the commercial structure. Loading facilities should not be located at the front of structures. When it is not possible to locate loading facilities at the rear of the building, loading docks and loading doors should not dominate the frontage. The docks should be screened from the street by landscaping and offset from the driveway openings.

7. Permanent outdoor storage should be screened by landscaping or materials compatible with the building's architecture. Site plan design should consider areas for temporary storage of vehicles, manufactured goods, raw materials, etc., so that this temporary storage has minimal impact on neighboring uses and the public.

F. Industrial

In addition to the guidelines set forth elsewhere in these Architectural Review Guidelines, the following guidelines are applicable.

1. All industrial facilities shall be designed to mitigate the impacts of noise, dust, fumes, and other nuisance conditions.
2. Energy conservation in site and architectural design must be utilized when possible.
3. Exterior support equipment should have not only a good functional placement, but also be located where it best integrates with the building's architecture.

V. ADDITIONAL GUIDELINES FOR SPECIFIC ZONES

In addition to the above guidelines, the following guidelines must be met for the designated building type. If there is a conflict between the general guidelines set forth above and the specific guidelines which follow, the specific guidelines shall prevail.

A. Public Facility

There will be specific guidelines prepared at a future date.

B. Mixed Use

There will be specific guidelines prepared at a future date.

VI. ADDITIONAL GUIDELINES FOR SPECIAL DISTRICTS AND SITES

In addition to specific building types which require special guidelines, there are certain areas of the City which are unique. These areas are identified below and, in addition to all the above guidelines which are applicable, compliance with the specific guidelines below is required. If there is a conflict between the guidelines set forth above and the specific guidelines which follow, the specific guidelines shall prevail.

A. Old Town

1. Purpose

The Design Guidelines included as part of the Old Town Lompoc Specific Plan are intended to promote a desired level of future development quality that will:

- a. Contribute to implementing the Old Town Lompoc Design Vision;
- b. Stimulate investment in and strengthen the economic vitality of Old Town Lompoc; and,
- c. Renew a positive physical image and identity of Old Town Lompoc.

These guidelines acknowledge the prevailing architectural characters and development patterns within Old Town today. The guidelines, therefore, do not seek to impose an overriding style, a limited color palette, or an artificial theme. They do seek to assist in promoting the positive design characteristics existing throughout Old Town today.

It is not the intent of these design guidelines to eliminate design freedom or discourage innovative design. The design guidelines complement the mandatory development standards contained in the City of Lompoc Municipal Code by providing good examples of appropriate design solutions and by providing design interpretations of the various mandatory regulations. The guidelines are less quantitative than the mandatory development standards and may be interpreted with some flexibility in the application to specific projects.

The construction of new buildings and rehabilitation of existing buildings within the Old Town Commercial District (OTC) in Lompoc is important for continued economic growth and diversity in the City. It is extremely important that new buildings erected in Old Town are compatible with existing buildings which reflect the architectural styles of the early to mid twentieth century. It is the desire of the City to have buildings in the Old Town Commercial District conform to architectural styles of this era rather than contemporary franchise architectural dictates from some other place.

Building façades, including the storefront, are the most important visual elements of commercial structures. Façades also experience significant change during a building's life and hold the most potential for creative alterations affecting both the character of the building and the streetscape. In an effort to promote quality design for new infill buildings, and the rehabilitation of existing buildings, the following specific storefront and façade guidelines are presented.

Signs in Old Town Lompoc should advertise a place of business or provide directions and information. An effective sign and graphics system functions not as a separate entity but as an integral part of the built environment. Carefully planned, signs communicate essential information, while also ordering and enhancing the architectural character of Old Town. Sign color, size, shape placement, and selection of lettering can attract or detract from a sign's effectiveness.

Public space associated with commercial buildings in Old Town Lompoc should serve as a transition from the outside to the inside of the buildings, should be complementary to the commercial buildings and should be supportive of pedestrian activity. Public areas should clearly communicate that all members of the public may occupy the space and communicate this message by being designed as extensions of the public space of the sidewalk. Methods of doing this include providing pedestrian amenities such as benches, fountains, and continuing the hardscape of the sidewalk. Successful public spaces also act as well-defined transitions from street and sidewalk to building door and interior spaces. Public space can add to the vitality of commercial areas, when designed and located in a manner that attracts pedestrian activities.

2. Organization

The design guidelines are organized into the following sections:

- a. *Purpose* provides an overview of the purpose, organization, applicability, and other aspects of the design guidelines.
- b. *Design Criteria* establishes basic rules of thumb for integrating new development into the existing urban fabric of Old Town Lompoc, and emphasizes the proper treatment of the Edge condition of existing and proposed development.
- c. *Old Town Commercial District* provides design guidelines, within an historic architectural context, for uses in the Old Town Commercial District of Lompoc. This section provides general design considerations as well as detailed guidance on specific subject area. It is divided into three categories: 1) architectural guidelines; 2) infill; and 3) storefront design.
- d. *Signs* sets forth general and specific guidelines which intend to enhance the image of Old Town and improve the effectiveness of signs for businesses.
- e. *Landscaping and Public Spaces* provides a basic landscape and plaza design framework which is to be used in conjunction with new development and infill, and as a helpful tool for property owners interested in upgrading the landscaping of existing development.
- f. *Designing for Crime Prevention* establishes numerous standards and guidelines to ensure that safety and security concerns are incorporated into new development and public improvements.
- g. *Secretary of the Interiors Guidelines* identifies the minimal standards for the rehabilitation of historic structures, sites, and buildings.

3. Interpretation

To aid the interpretation of these guidelines, a development applicant should understand the meaning of should, encouraged, and discouraged:

Guidelines which employ the word should are intended to be applied as stated. An alternative measure may be considered, however, if it meets or exceeds the intent of the guideline.

Guidelines using the words encouraged or discouraged are not mandatory, but express a more or less desirable design solution.

4. Applicability

The provisions of this section are applicable to all development within the Old Town Commercial District.

Any new building, additions, exterior alterations, or landscaping, and any modification to an approved landscaping plan or parking lot design should adhere to the Design Guidelines as applicable. It is important to note, however, that these Guidelines do not affect existing buildings which are not proposed for new construction, exterior alterations, landscaping or changes in the parking lot layout.

The Design Guidelines will be utilized during the City's Development Approval process (and should be provided to applicants during pre-application conferences), to encourage the highest level of design quality and at the same time provide the flexibility necessary to encourage creativity on the part of project designers in response to existing site conditions.

5. Exemptions

When in compliance with all other City ordinances, and with the standards and provisions of the Old Town Lompoc Design Vision contained in the Old Town Specific Plan, the following projects are exempted from all provisions of these Design Guidelines:

- a. Construction underground, which will not leave any significant, permanent marks on the surface after completion. Utility boxes, pipes, and poles shall be considered significant permanent marks.
- b. Maintenance work on buildings, landscaping, or grounds (including parking lots) which does not significantly alter the appearance or function of the building, landscaping, or grounds.

- c. Interior remodeling work.
- d. Landscape maintenance and upkeep, including relatively minor replacement of plants other than trees.
- e. Temporary uses and structures as defined by the Lompoc Municipal Code.
- f. Routine roof maintenance and repair. Overall roof reconstruction is subject to these Design Guidelines.

6. Context & Compatibility

Existing buildings, streetscape, and landscaping establish the frame of reference for new development. This is particularly true throughout Old Town Lompoc where an historic urban fabric is well represented by traditional commercial structures such as the Lilley Building (101 North H Street) and the building on 111 West Ocean, and by art-deco styles exemplified in the Rudolph Building (105-107 South H Street). To the extent that the scale, placement, and character of new buildings or building additions blend with what is already there, Old Town is continuously woven together. Conversely, regular or blatant disregard of existing patterns disrupts the essential character image, creates voids in the built environment, and compromises the functionality of Old Town.

Generally, to create harmony between the existing urban fabric and new elements introduced into Old Town, all new structures, additions, and uses should be compatible with the prevailing historic architectural character of the surrounding area. Existing site amenities, such as trees, should be preserved and should become part of any new project or addition, and structures and activities should be located and designed to avoid creating nuisances and hazards for adjoining properties, particularly residential properties.

The concept of “compatible” design is one of the most important concepts to recognize when using these design guidelines. Compatible designs do not seek to imitate the historic architecture found in Old Town, but do reflect their surroundings in terms of design concepts – mass, scale, rhythm, color, materials, and building arrangement. Compatible designs will be in harmony with the best designs of surrounding developments.

Guidelines pertaining to conceptualism and compatibility include:

- a. All new construction and development should incorporate those characteristics of Old Town that exhibit a positive distinctive architectural style and/or established functional or landscape patterns.
- b. New buildings and additions should be sited in a manner that will complement rather than conflict with existing adjacent buildings, landscape, streetscape, parking, and access.
- c. Transitions between existing and new buildings or additions should be gradual. The height and mass of new projects or construction should not create abrupt changes from those of existing buildings.
- d. Natural amenities, such as mature trees and views, should be preserved and incorporated in the design of Old Town projects where applicable. Buildings should not back up to existing or potential amenities.
- e. Buildings should be oriented to connect with high activity areas, such as restaurant dining areas or major pedestrian areas, in order to create connections and linkages.
- f. Noise or odor generating activities in general, and loading areas, trash and storage areas and rooftop equipment in particular should be located as far as possible from adjacent residences and should never be located next to residential properties without fully mitigating their negative effects. They should also be screened from view on all major streets and side streets in Old Town.
- g. Commercial and other non-residential buildings and associated activity areas should be oriented so to avoid significant shading of adjacent residences and compromising residents' privacy.

- h. Where Old Town buildings are adjacent to residential neighborhoods, Old Town buildings should maintain low profiles and heights should be stepped down to the height of adjacent residential zones, utilizing architectural elements such as gables or hip roofs to reduce building mass.
- i. Windows in commercial and other non-residential buildings should be oriented to preclude a direct line of sight into adjacent residential buildings, or property.

7. Design Criteria

a. Infill

Since these buildings will be constructed on vacant or underutilized lots, thus filling in the street frontage, they are called “infill” construction.

The design of an infill building, particularly its front façade, should be influenced by the other façades on the street but should not attempt to copy them. The infill structure should be sympathetic and compatible with surrounding buildings in terms of mass, scale, height, façade rhythm, placement of doors and windows, storefront design, color and use of materials.

Since good infill design responds directly to its surroundings, it is not possible to develop specific guidelines which apply in every case. There are, however, several general design principles which should govern the visual ties between a new infill building and its neighboring historic structures found in Old Town Lompoc.

i. Façade Proportion

- (a) The characteristic proportion (relationship of height to width) of existing façades should be respected in relation to new infill development.

- (b) Whenever an infill building is proposed which is much wider than the existing characteristic façades on the street, the infill façades should be broken down into a series of appropriately proportioned “structural bays”, storefronts, or components typically segmented by a series of columns or masonry piers which frame window, door and bulkhead components.
- (c) An infill building should not be much higher than the height of surrounding historic structures in Old Town. In no case should any new buildings exceed forty-five (45) feet in height.

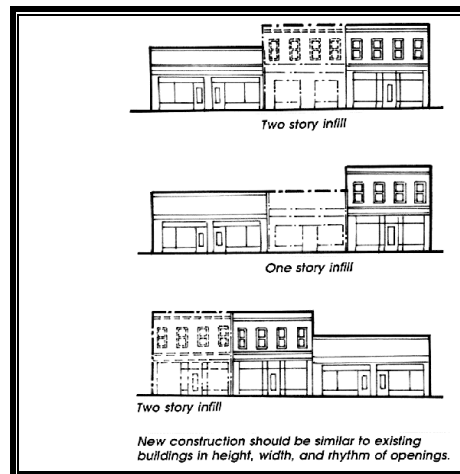

ii. Proportion of Openings

- (a) Maintain the predominant difference between upper story openings and street level storefront openings (windows and doors). Usually, there is a much greater window area at the storefront level for pedestrians to have a better view of the merchandise displayed behind as opposed to upper stories which have smaller window openings.
- (b) Whenever an infill building is proposed which has two adjacent commercial structures, attempt to maintain the characteristic rhythm, proportion and spacing of existing door and window openings.



iii. Horizontal Rhythms

- (a) Whenever an infill building is proposed, identify the common horizontal elements (e.g. cornice line, window height/width, and spacing) found among local historic structures and develop the infill design utilizing a similar rhythm or alignments.
- (b) If maintaining a horizontal rhythm or alignment in an infill building is very difficult or otherwise impossible, the use of fabric canopies or awnings is strongly encouraged to establish a shared horizontal storefront rhythm.

iv. Wall Articulation

- (a) Long, blank, unarticulated street wall façades without window or door openings are strongly discouraged and should be divided into a series of structural bays (e.g. characterized by masonry piers which frame window and door elements).

- (b) Monolithic street wall façades should be “broken” by vertical and horizontal articulation (e.g. sculpted, carved, or penetrated wall surface defined by recesses and reveals) characterized by:
 - (a) breaks (reveals, recesses) in the surface of the wall itself;
 - (b) placement of window and door openings;
 - (c) the placement of balconies, awnings, and canopies.

- (c) Avoid large unbroken façade surfaces at the storefront level. This can be achieved in a number of ways including:
 - (a) dividing the façade into a series of display windows with smaller panes of glass;
 - (b) constructing the façade with small human scale materials such as brick or decorative tile along bulkheads;
 - (c) providing traditional recessed entries;
 - (d) careful sizing, placement and overall design of signage;
 - (e) providing consistent door and window reveals.

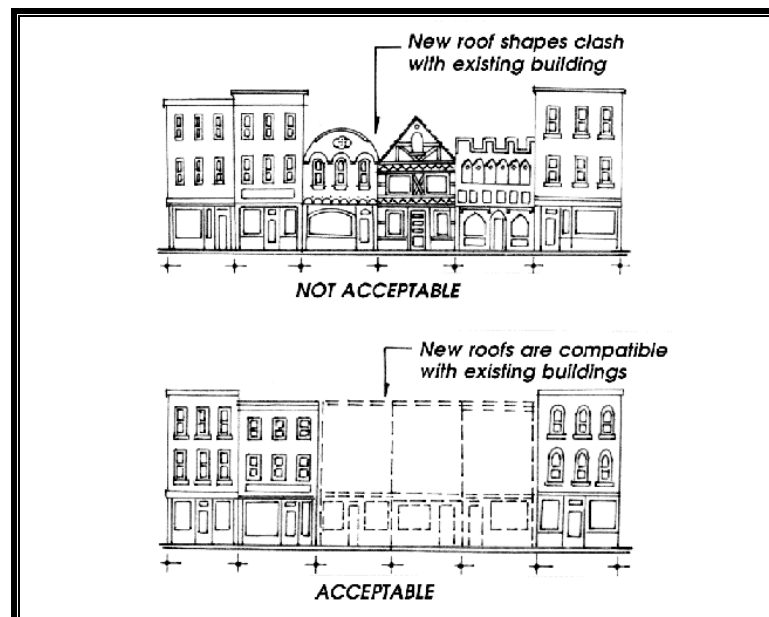

v. Roofs

- (a) Roofs may be flat or sloped consistent with surrounding buildings. Older twentieth century commercial vernacular buildings used flat roofs with decorative parapets and heavy cornice lines. The visible portion of sloped roofs should be sheathed with a roofing material complementary to the architectural style of the building and other surrounding buildings.
- (b) Cornice lines of new buildings (horizontal rhythm element) should be aligned with buildings on adjacent properties to avoid divergent clashes in building height.
- (c) Radical roof pitches which create overly prominent or out-of-character buildings such as A-frames, massive mansards, geodesic domes, or chalet style buildings are strongly discouraged.
- (d) The use of decorative parapets is encouraged if the parapets have substantial visual interest which incorporates vertical articulation.

vi. Building Material Palette

Building materials to be used on infill buildings are to be consistent with the materials used on significant adjacent buildings.

The following are recommended materials for infill structures (not including existing buildings): Building Wall – Clear glass, glass block (storefront only), glass block (transom), exterior plaster (smooth trowled), new or used face-brick, cut stone, rusticated block (cast stone), horizontal clapboard, lap, wood siding, ceramic tiles (bulkhead), stucco, horizontal plastic clapboard. Roofs (where visible): standing seam metal roofs, class “A” composition shingles (limited to refurbishment of residential structures).

The following are discouraged materials for infill structures (not including existing buildings): Building Walls – imitation masonry (e.g. imitation, rusticated block) of any kind, reflective or opaque glass, imitation stone or flagstone parquet, rough-sawn or “natural” (unfinished) wood, “pecky” cedar, used brick with no fired face (salvaged from interior walls), vertical wood siding (board & batten), coarsely finished “rough-sawn” on rustic materials (e.g. wood shakes, barnwood, board and batten or T-111 siding), plastic panels, steel or metal siding. Roofs (where visible) – crushed stone, shake brightly colored tile (orange, blue, etc.), corrugated fiberglass.

vii. Mechanical Equipment Screening

Any mechanical or utility equipment (whether on the roof, side of building, or ground) shall be screened. The method of screening shall be architecturally integrated with the structure in terms of materials, color, shape, and size. Where freestanding mechanical equipment is provided, a continuous solid screen is desirable. On-roof mechanical equipment should be screened by solid building elements (e.g. parapet wall, roof well) instead of add-on screening (e.g. wood or metal slats).

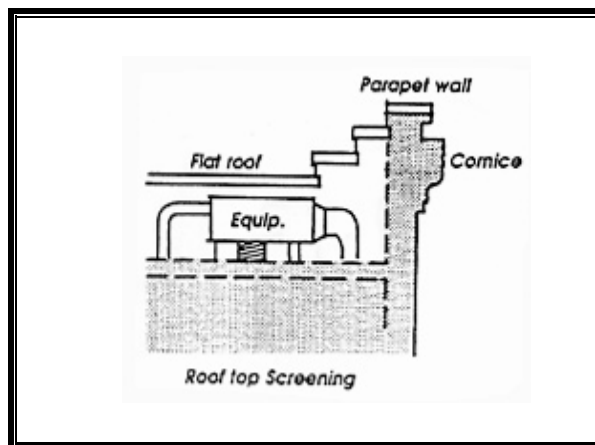

viii. Setbacks and "Build To" Lines

- (a) The first floor of any new infill building shall be built at the front property line. If a building proposes to have a plaza area located between its front and the front property line, this may be allowed on a case-by-case basis. In no event will surface parking be allowed between the building and front property line.
- (b) Canopies, trellises, and other accessory structures which are relatively open and do not restrict pedestrian or vehicular movement may project over the right-of-way with City or Caltrans encroachment approval

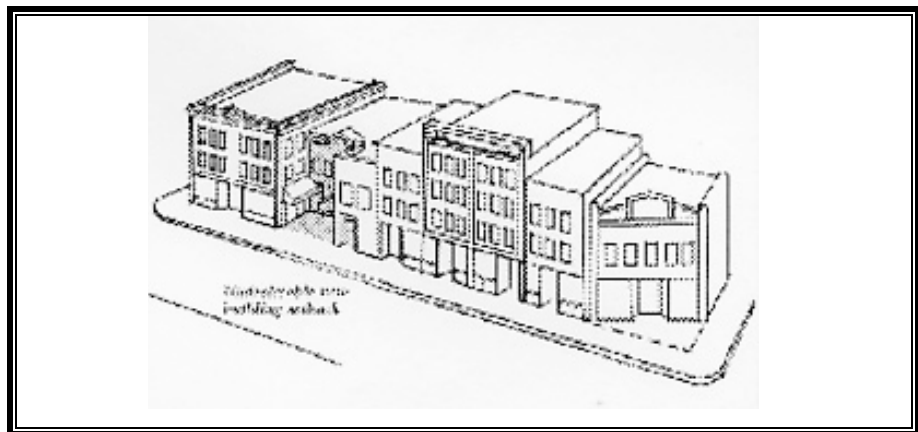

ix. Street Orientation

- (a) It is strongly encouraged that the front building façade be oriented parallel to the street.

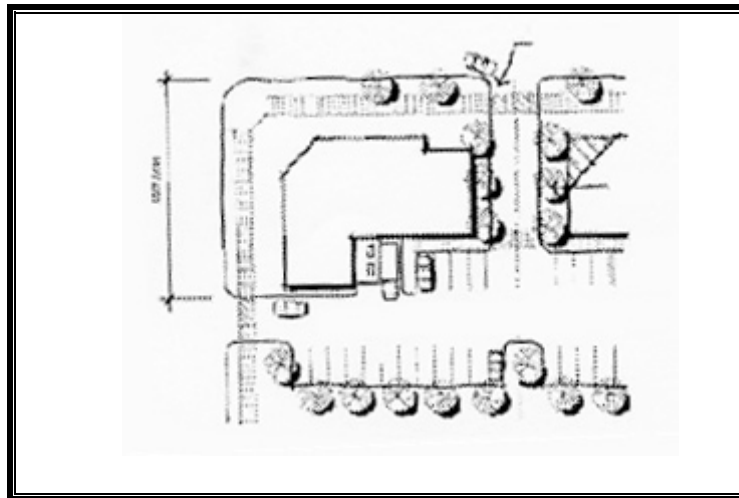

- (b) Storefronts should be oriented toward the primary street frontage. While side or rear entries are desirable, the predominant major building entry shall be oriented toward the primary street.

x. Parking Lot Orientation

- (a) Parking lots shall be located to the rear or sides of buildings.
- (b) Locating parking lots between the front property line and the building storefront is prohibited anywhere along Ocean Avenue or H Street.
- (c) Rear parking lots shall be designed and located contiguous to each other so vehicles can travel from one private parking lot to the other (reciprocal access) without having to enter the street.
- (d) Private parking lots with side street frontage should be attractively landscaped with trees and shrubs in order to continue the linear street frontage created by the existing flanking buildings and to screen parked vehicles. Low masonry garden walls or landscaping (three (3) feet maximum height) at the setback line are also encouraged to screen parking from the side street.

- (e) Common reciprocal access driveways which provide vehicular access to adjacent parcels are required. Shared parking and circulation aisles coordinated between adjacent businesses and/or developments are also encouraged.
- (f) Whenever possible, locate parking lot entries on side streets in order to minimize pedestrian/vehicular conflicts along the primary street frontage.
- (g) Design parking areas so that pedestrians walk parallel to moving cars. Minimize the need for the pedestrian to cross parking aisles and landscape area.
- (h) Parking garages should be designed to fit in with the existing urban fabric in Old Town Lompoc.
- (i) Parking garages should provide access to retail stores at the sidewalk level whenever possible.

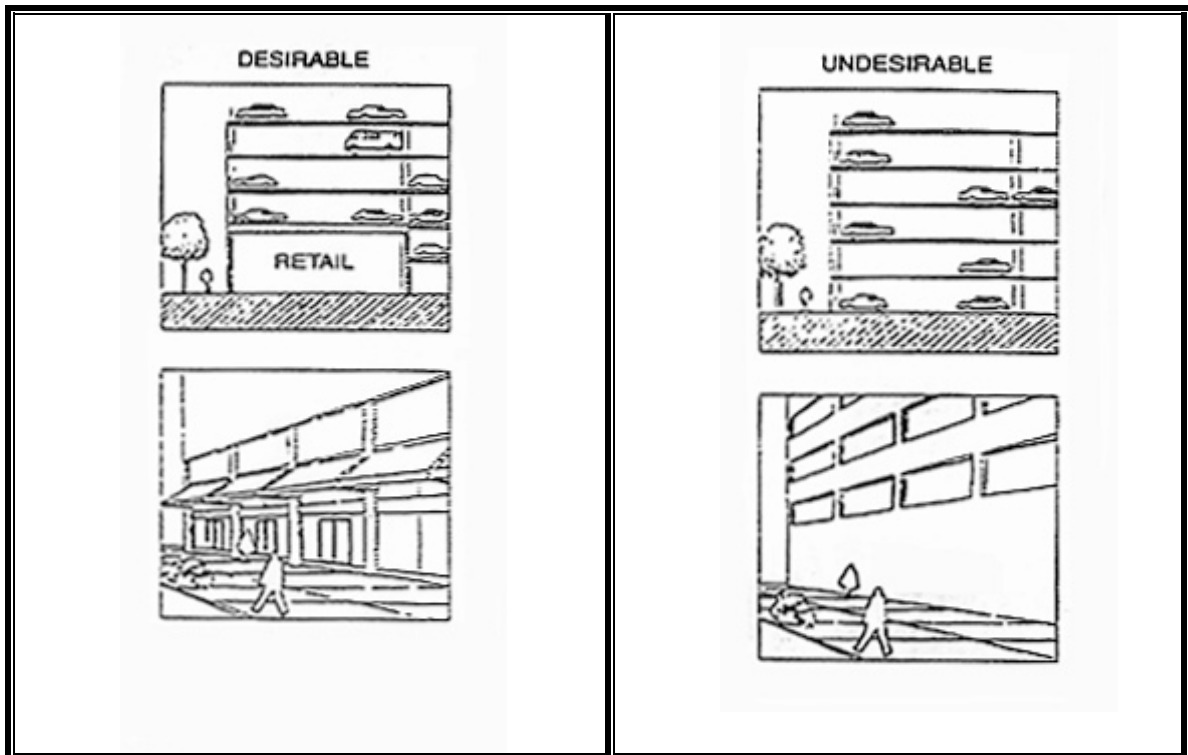

b. Storefront Design

i. Entries/Doorways

Commercial storefront entries are typically recessed and/or sheltered by a covered arcade structure, canopy, or awning. This provides more area for display space, a sheltered transition area to the interior of the store, and emphasizes the entrance. Recessed entries should be retained and are strongly encouraged in new storefront construction.

ii. Facade Color

- (a) The use of light, subdued, or neutral (earth tone) colors and natural building materials, such as brick, wood, or stone are encouraged.
- (b) Adjacent buildings should be painted different, but complementary, colors.
- (c) One base color should be used for an entire façade. Different trim colors are encouraged, but should not exceed three different colors.
- (d) Different window frame and sash colors are encouraged but should complement the main color of the building.
- (e) Primary colors shall be kept to a minimum on façade exteriors.
- (f) Stripes, polka dots, checkerboard patterns, and other distracting paint combinations are prohibited.

iii. Awnings and Canopies

- (a) Awnings are encouraged and should have a single color or two-color stripes. Lettering and trim, utilizing other colors is allowed but will be considered as sign area.

- (b) Awning shape should relate to the window or door opening. Barrel shaped awnings should be used to complement arched windows while rectangular awnings should be used on rectangular windows.
- (c) All awnings should be well-maintained, washed regularly and replaced when faded or torn.
- (d) When there are several businesses in one building, awnings of the same color should be used with simple signs on the valance flap that may vary in type style and color to differentiate the individual businesses within the building.

iv. Door and Window Design

- (a) Accentuate the door with simple details such as a brass door pull, brass kick plate or an attractive painted sign.
- (b) Doors to retail shops should contain a high percentage of glass in order to view the retail's contents.

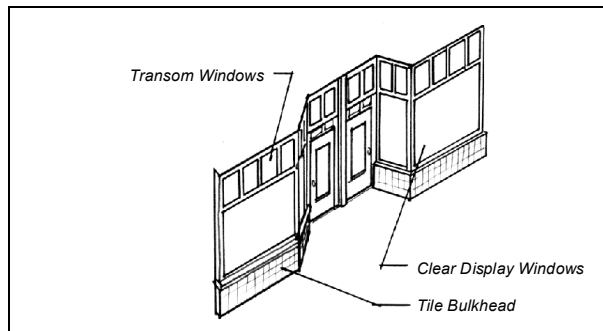

- (c) When considering new window fenestration (window size, size of windowpanes, window materials), it is important that the new design be sympathetic and compatible with the façade theme of the whole block (street wall).

- (d) Use of clear glass (88% light transmission) on the first floor is strongly recommended.
- (e) Storefront windows should be as large as possible and no closer than 18" from the ground (bulkhead height). By limiting the bulkhead height, the visibility to the storefront displays and retail interior is maximized. Maximum bulkhead heights for new construction shall be 36".
- (f) Discourage introduction or change of the location or size of windows or other openings that alter the architectural rhythm, alignment or character of the original building.
- (g) Air conditioning units placed in individual windows and window transom areas are prohibited.
- (h) Permanent, fixed security grates or grilles in front of windows are prohibited. If security grilles are necessary, they should be placed inside the building behind the window display area.

v. Rear Entrances

- (a) Signs should be modestly scaled to fit the casual visual character of the alley or rear parking area.
- (b) An awning can soften rear façades and provide a pleasant protected space.



- (c) The rear entry door should be wood and glass similar to the front door. Special security glass (i.e. wire imbedded) is permitted.
- (d) Security lighting should be modest and should focus on the rear entry door.
- (e) Selective use of tree plantings, potted plants and other landscaping can subtly improve a rear façade.

vi. Window Replacement

- (a) If a window has deteriorated beyond repair or is missing, the replacement should match the original window in terms of design and materials. Replacement windows should always fill the entire existing opening and duplicate the original window pattern. For example, a double hung sash window should not be replaced by a single fixed pane of glass.
- (b) Avoid the use of windows and shutters that are not in keeping with the original style of the building.



vii. Door Replacement

Every effort should be made to maintain and repair an original door, if possible.

viii. Removal of Existing Canopies and Metal Awnings

Metal aluminum canopies have a thin, unsubstantial, and “tacked on” appearance which is inconsistent with the desirable design concept for Old Town Lompoc. Existing metal canopies should be removed and, if appropriate, replaced with fabric awnings, consistent with the architectural style of the building.

ix. Removal of Elements Inconsistent with Original Façade

Existing building elements incompatible with the original façade design of the building should be removed. These include: overdone exterior embellishments and “modernized” elements such as board and batten or other themed materials, or wood covered transom windows.

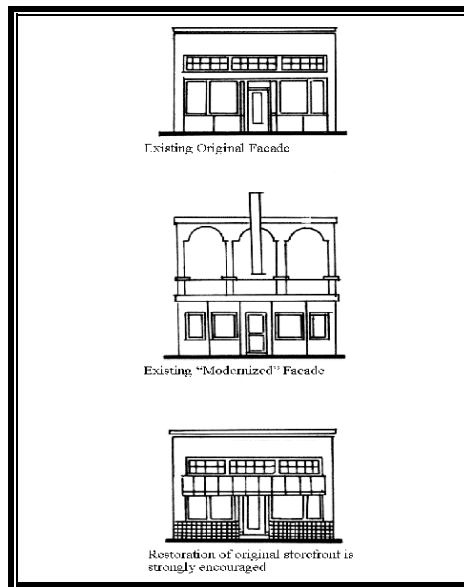

x. Preserve Traditional Decoration

Many times in the remodeling of storefronts, original decorative details are intact as visual “leftovers” or simply covered up with new construction. If the building is to be refurbished, these forgotten details should not be wasted. If enough of them remain, they can be restored as part of the original design. If only a few remain, they can be incorporated as design features in a new storefront. In either case, the design of any improvements should grow out of the remaining traditional details and create a harmonious background which emphasizes them.

xi. Selection of Building Materials

Some contemporary materials are often used to apply “shopping mall” style façades over the rich character of traditional Old Town buildings. Materials such as cedar shakes, textured plywood, stone veneer, stucco veneer, and plastic are not appropriate for use on traditional façades in Old Town Lompoc.

8. Signs

a. An effectively designed sign should

- i. Be compatible with surrounding physical and visual character of the area;
- ii. Promote the individuality of establishments;
- iii. Identify the business clearly and attractively;
- iv. Enhance the building on which it is located;
and
- v. Reduce the amount of visual clutter caused by excessive and poorly placed signs.

Chapter 17.108 of the City's Zoning Ordinance, Sign Regulations, has guidelines to control the size, location, and number of signs, but code restrictions alone may not be enough. Design criteria are needed to encourage and coordinate well-designed signs. The following sign guidelines are intended to assure the local merchant that all other Old Town commercial establishments are similarly regulated.

Some existing signs contribute to the Old Town sense of history and should be preserved. These signs include the following: Rice Bowl neon signs, Oddfellows Building neon sign, Stillmans, Michael's, The Star Motel, and the Lompoc Theater.

b. Preferred Sign Types

The following sign types are preferred:

- i. Under canopy signs;
- ii. Business wall-mounted identification signs in sign board area at upper portion of first story;
- iii. Awning signs;
- iv. Projecting/hanging signs;
- v. Murals and supergraphics not advertising a business (painted on a wall surface);

- vi. Permanent painted window signs, first floor only and limited to 25% of the window area
- vii. Building signs containing the name of the business at rear entrances used by customers; and
- viii. Signs made of carved or sandblasted wood or metal.



c. General Design Guidelines

i. Clear Sign Message

- (a) Use a brief message. The fewer the words, the more effective the sign. A sign with a brief, succinct message is simpler and faster to read, looks cleaner and is more attractive.
- (b) Avoid hard-to-read, overly intricate typefaces. These typefaces are difficult to read and reduce the sign's ability to communicate.
- (c) Lettering should be in proportion to the size of the sign. As a rule of thumb, the recommended size of letters is between one-third (1/3) to one-half (1/2) the height of the sign.

- (d) Avoid signs with unusual shapes. Signs that are unnecessarily narrow, oddly shaped, or unrelated to the products or services being provided on site can restrict the legibility of the message. If unusual shape is not symbolic, it is probably confusing.
- (e) Use widely recognized logos rather than print/text whenever possible
- (f) Signs should be smaller in scale if oriented to pedestrians. The pedestrian-oriented sign is usually read from a distance of fifteen to twenty feet; the vehicle-oriented sign is viewed from a much greater distance. The closer a sign's viewing distance, the smaller that sign need be.



ii. Sign Color

- (a) Colors should be selected to contribute to legibility and design integrity of signage. Even a well-designed sign may be unattractive and a poor communicator because of poor color selection.
- (b) A substantial contrast should be provided between the color and material of the background and the letters or symbols to make the sign easier to read during day and night conditions.

- (c) Limit colors to three (3) on a single sign. *Registered or copyrighted logos or trademarks shall be allowed with a maximum of four (4) colors.* Color is most effective when used simply. Too many colors, particularly accent colors, may distract the reader, reduce legibility, and make the sign less effective.
- (d) Vertical or horizontal wooden signs can be effectively utilized in a variety of different ways on windows, building surfaces or as accent bands. A wooden wall sign can be painted or stained and sealed for a more natural look, depending upon the appearance of the surrounding structures. Lettering can consist of metal or raised wood, and when placed within a sign band, will serve to unify the building façade. Carved or sandblasted wood signs are also appropriate.
- (e) Metal sign panels can utilize raised lettering on metal bands. Text and lettering can also be applied directly to a flat metal sign band with letters consisting of wood, acrylic or metal.

iii. Sign Architectural Compatibility

- (a) Signs should make a positive contribution to the general appearance of the street and neighborhood in which they are located.
- (b) Sign size should be proportionate. The size and shape of a sign should be proportionate with the scale of the structure.

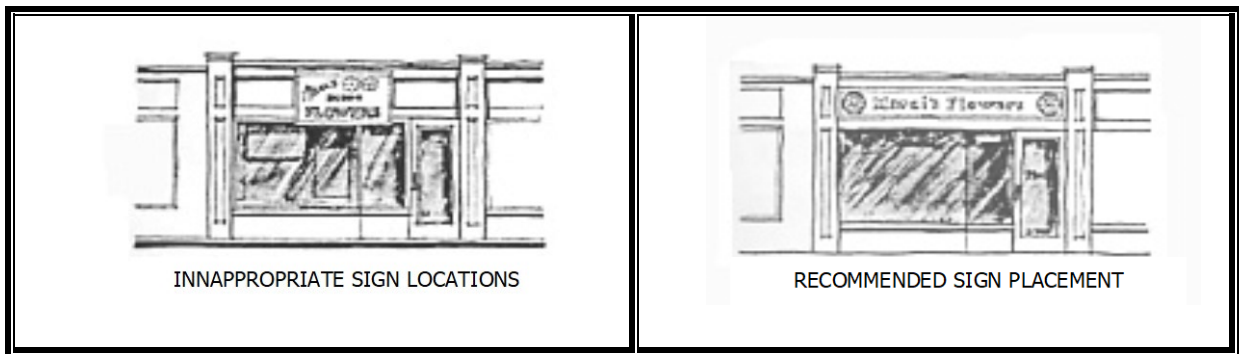

- (c) Signs should be an appropriate scale with the building on which they are placed and should not overwhelm the architecture of the building and the character of the neighborhood.
- (d) Place wall signs to establish façade rhythm, scale, and proportion where façade rhythm doesn't exist. In many buildings that have a monolithic or plain façade, signs can establish or continue appropriate design rhythm, scale, and proportion.
- (e) As an alternative to an attached sign, lettering may be painted directly on the building façade. This method resembles a wooden or metal band but does not require the introduction of another material.

iv. Wall Mounted Signs

The identification of each building or store's address in six inch high numbers over the main entry doorway or within ten feet of the main entry is recommended.

Sign lettering for storefront wall mounted signs should meet the following recommendations:

- (a) For storefronts 30' wide or less, a maximum letter height of 8" is recommended;

- (b) For storefronts 30'-60' wide, a maximum letter height of 12" is recommended; or
- (c) For storefronts 60' wide or greater, a maximum letter height of 16" is recommended.

v. Awning Signs

- (a) An awning is permanently attached to a building or can be raised or retracted to a position against the building when not in use. An awning sign is a message painted, printed, sewn, or stained onto the awning or awning flap.

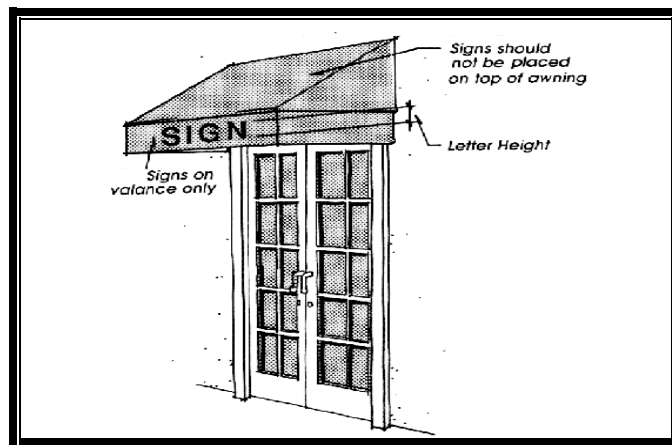

- (b) The sign on awnings may be allowed on the shed portion of the awning but are preferred on the valance flap. The flap should be at least eight (8) inches in height so that the letters and symbols can be big enough to read easily.
- (c) The color of an awning sign should be compatible with and complementary to the color and material of the building to which it is attached.

vi. Banner Sign

A banner sign is a logo or design placed on a lightweight material that can move with the wind. Banner signs should not be confused with flags or pennants. A banner sign is intended to add liveliness, color, and a sense of movement to a pedestrian-oriented street and sidewalk.

- (a) Banners are encouraged along pedestrian-oriented streets, in plazas, and in commercial centers.
- (b) Banners should not extend more than five (5) feet from the building or one-third (1/3) the width of a public sidewalk, whichever is less. In addition, banners should be measured eight (8) feet above ground at its lowest point.
- (c) Banners along the same block of a street should be set at generally the same angle from the buildings.
- (d) Banners should reflect the informality and excitement of color and movement.
- (e) Banners shall not be used in lieu of permanent signage.
- (f) Banners shall be maintained in good repair and in a clean and attractive condition. Torn, bent, faded, and/or dirty banners shall be replaced or removed.

vii. Hanging Sign

A hanging sign is a sign suspended from a support and projects from the building wall or mounted directly over a pedestrian walkway or arcade. Similar to awning signs and banners, a hanging sign can add interest and vitality to a street. Hanging signs can include pictorial images, logos, and symbols.

A hanging sign is generally intended to be read by pedestrians along a sidewalk or arcade, and motorists in slow-moving vehicles.

- (a) The size of a hanging sign should be proportional to the building façade to which it is attached and should not exceed ten (10) square feet.
- (b) A hanging sign should be hung perpendicular to and should not project more than four (4) feet from the face of the building.
- (c) To minimize visual clutter, hanging signs should not be located within close proximity to other hanging signs or projecting signs, preferably at least 25 feet from each other.
- (d) The placement of a hanging sign should not impede the safe movement of people or vehicles within a public right-of-way and should be properly secured to a building in a structurally sound manner.

viii. Window Sign

A window sign is a permanent sign painted on or attached to the inside of a window and is designed to be viewed principally from outside the business by pedestrians and motorists using the adjoining parking lot.

- (a) To minimize clutter, window signs should not occupy more than twenty-five (25) percent of the total area of the window in which they are displayed.
- (b) The sign copy of window signs should be proportional to the glass surface area.
- (c) Signs should be restricted to ground floor windows facing the primary street frontage or adjoining parking lot.

- (d) Temporary window signs should be allowed to identify special events and sales provided such signs are removed immediately following the event.

ix. A-Frame and Portable Signs

A portable sign is any sign or advertising device which rests on the ground and is not designed to be permanently attached to a building or permanently anchored to the ground. A-frame signs in Old Town are intended to attract pedestrians, not passing motorists.

- (a) No existing business should be allowed to have more than one A-frame sign.
- (b) A-frame signs shall have a maximum sign area of six (6) square feet. The maximum height, from ground level, should be three (3) feet and the maximum width should be two (2) feet.
- (c) A-frame signs shall only be located on private property or within the public right-of-way, provided they do not interfere with vehicle access, pedestrian movement, or wheelchair access; (4) feet of unobstructed area shall be maintained along all sidewalks and building entrances accessible to the public.
- (d) A-frame signs shall not encroach into required off-street parking areas, public roadways or alleys, and may not be arranged so as to create site distance conflicts or other traffic hazards. Portable signs shall not be placed within the corner curb return areas of intersections.
- (e) A-frame signs shall be utilized only during regular business hours and should be removed during non-business hours.

- (f) Materials for portable signs should be of a permanent nature and not be subject to fading or damage from weather. The use of paper or cloth is not permitted unless located within a glass or plastic enclosure.
- (g) Portable signs should be designed in an attractive manner and present an image of quality and creativity for Old Town Lompoc. White background is prohibited. A dark background with light letters is preferred.
- (h) Portable signs should be maintained in a neat, orderly fashion so as not to constitute an unsightly appearance or a public nuisance in Old Town.

x. Freestanding Signs

- (a) Freestanding signs, including monument and pole signs, are prohibited in Old Town Lompoc.

9. Landscaping & Public Spaces

a. Introduction

Landscaping in Old Town Lompoc shall achieve three specific ends:

- ❖ to beautify Old Town
- ❖ to soften commercial development
- ❖ to unify the area as a pleasant environment for residents and visitors alike

These three ends will be accomplished by a recognizable use of repeated planting treatments. Consistency and continuity within the street right-of-way and building setback areas is extremely important.

b. General Landscape Design Guidelines

All development is encouraged to follow these general landscape guidelines:

- i. Save healthy existing mature trees.
- ii. Use specimen trees (boxed trees) for immediate effect and accent.
- iii. Give consideration to rapidly growing trees.
- iv. Emphasize use of varieties which require low maintenance in public and commercial areas, especially in large landscape areas.
- v. Use boxed and potted plants in clay, stone, or wood containers, especially for enhancement of sidewalk shops. The color and style of the containers shall be subject to approval by the City when in public right-of-way.
- vi. Give preference to ground covers which require little maintenance.
- vii. Vines and climbing plants integrated upon building and perimeter garden and building walls are strongly encouraged.
- viii. The use of materials such as crushed rock, redwood bark chips, pebbles, and stone or masonry slabs should not be used in place of live plant materials in landscape areas. Use of such materials shall be subject to approval by the City.
- ix. Use color plantings at the base of a building in planter boxes, and focal points.
- x. Trees should be planted using industry accepted methods. Trees and shrubbery should not be located so that they interfere with the effectiveness of parking lots, street lighting, and storefronts.
- xi. Landscaping should not obstruct the sightlines of motorists or pedestrians, especially at pedestrian crosswalks.
- xii. Trees and shrubbery should not be located so that they interfere with the effectiveness of parking lot and street lighting.

- xiii. Landscaping material, so long as it is properly maintained, is the preferred method used to obscure the view of any parking or storage area adjacent from a public street or pedestrian area.
- xiv. Landscape screen plant materials should be large enough at planting to provide effective screening, and be capable of growing to the height and density desired within a reasonable period of time.
- xv. All commercial projects should provide complete automatic sprinkler or drip irrigation systems.
- xvi. Keep all plants healthy and growing with all planting areas free of weeds and debris.

c. Public Spaces

i. Plazas

- (a) Plazas should be designed to supplement, rather than detract from street activity.
- (b) The function and appearance of the plaza or courtyard should not be dominated by stairs or elevators.
- (c) Where inconsistent setbacks occur along the street in Old Town, plazas should be considered to compensate for the broken building edges.
- (d) Retail shops, restaurants, offices, or other activity-generating uses should be located at the edges of plazas; blank walls should be minimized adjacent to such pedestrian spaces.
- (e) Plazas should be designed with unimpeded lines-of-sight to and from the public sidewalk; and physical access should be provided from the public sidewalk to plazas.

- (f) Plazas should be physically and visually accessible from the public sidewalk. Security fences, walls, and entry gates shall not block the sidewalk edge of the plaza or views into the plaza. At least 15 feet of building frontage should be transparent or visually penetrable to provide entry to and views into the plaza.
- (g) Entries to the plaza, and storefront entries within the plaza, shall be designed and lighted so they do not create hiding places.
- (h) Visual features, such as public art or a fountain, should be incorporated in plazas to attract pedestrians.
- (i) Seating should be provided in plazas. Where applicable, plaza users should be provided with a choice between active (i.e. observing nearby activity) and passive (i.e. private) seating.
- (j) Shade trees or other elements providing relief from the sun should be incorporated within plazas, in a manner that does not impair pedestrian movement.
- (k) A majority of the gross area of the plaza should have access to sunlight for the duration of daylight hours. A mix of direct sunlight and shade should be provided. No more than 30 percent of a plaza should be covered with a roof. Canopies, awnings, cantilevered overhangs, or balconies may project over the ground floor but should not prohibit the penetration of sunlight to the ground floor.
- (l) At least 10 percent of the plaza's surface should be landscaped. Shade trees are strongly encouraged.

- (m) Paving and furniture used in private plazas should complement streetscape elements used in the public right-of-way throughout Old Town Lompoc.
- (n) Plazas should provide at least one sitting place for each 200 square feet of plaza in addition to permitted outdoor dining.
- (o) Plazas, including all entrances and exits, should be fully illuminated ½ hour after sunset to ½ hour before sunrise to facilitate natural surveillance opportunities and to discourage illegitimate activities. Lighting should be designed to help define, order, and further develop the design concept of the space in a manner that appears welcoming to pedestrians.
- (p) Signage or other mechanisms should identify that the plaza is available for public use during business hours.
- (q) Security gates and security fencing may not be used in plazas. These elements may only be permitted by the City Planner.
- (r) Landscaping for the plazas should provide special interest through plant materials with integral interest such as special foliage color, seasonal changes in plant habit, scent, or floral display.

ii. Entry Courtyards

- (a) Courtyards, where used, should include a focal element of sculpture and/or water, simple plantings and simple sitting niches with a view of the activity within the space.
- (b) Courtyard trees should be drought tolerant and be planted in simple geometric symmetries.

- (c) Courtyards should be designed to provide both visibility and separation from the street.

iii. Public Art

- (a) Art associated with commercial buildings in Old Town Lompoc that invites participation and interaction, adds local meaning, interprets the community by revealing its culture or history, and/or captures or reinforces the unique character of a place is encouraged (i.e. murals, kinetic sculptures).
- (b) The setting of public art should be considered in its design; likewise, the impact of physical space and nearby structures on public art should be considered.

10. Designing for Crime Prevention

The concept of crime prevention through environmental design (CPTED) includes a wide variety of strategies aimed at reducing opportunities for crime through the proper design and effective use of the built environment. Key components of CPTED include:

- ❖ Natural access control involving the use of pathways, paving treatments, lighting, landscaping, fencing, signs, and other built features to guide ingress and egress and to discourage or eliminate public access into areas.
- ❖ Natural surveillance focusing on the placement and design of physical features and the arrangement of uses to maximize opportunities for natural surveillance.
- ❖ Territorial reinforcement which entails design features and physical elements which convey a sense of ownership and stewardship over a space. Unique paving patterns, artwork, signs, landscaping, lighting standards and streetscape components, and other physical elements can be installed and maintained to communicate a sense of pride and proprietorship.

a. Design Considerations

CPTED involves design of physical space in the context of the needs of the bona fide users of the space, the activity planned for the space and the predictable behavior of bona fide, as well as, illegitimate users. The following CPTED-based guidelines are to be considered for all development within the Old Town area.

- i. Utilize plants and low fencing to direct movement and restrict, symbolically, areas where people should not enter.
- ii. Minimize the height of parking lot screening (shrubs or low walls) to allow a visible “window” above three (3) feet and below seven (7) feet.
- iii. Restrict the number of entry points into a development or parking lot.
- iv. Improve safety behind buildings through use of:
 - (a) adequate security lighting;
 - (b) limited access (walls, fences, gates, shrubs);
 - (c) introduction of activities (e.g. rear entrances for commercial activities) that increase surveillance;
 - (d) surveillance through windows or with cameras; and
 - (e) maintenance storage areas and alleys.
- v. Use security fencing/walls with view ports or sections of wrought iron grille work to allow views into the development while restricting access.
- vi. Identify building numbers (street addresses) by posting numbers so they are visible from the public right-of-way wherever possible.

- (a) Single-family homes should use six inch numbers/letters (in height) when displayed at the first story level.
 - (b) Buildings other than single-family homes should use twelve inch numbers/letters (in height) when displayed at the first story level.
 - (c) Building numbers/letters displayed above the first story should be a minimum sixteen inches in height.
 - (d) Multiple-family residences should include building numbers of four inches in height if illuminated and six inches if non-illuminated.
- vii. Multi-tenant developments (residential and non-residential) should include directories at site entrances identifying the locations of buildings, suites, apartments, etc. and on-site landmarks, including management offices and access points.
- viii. Factors to consider in the design of new development, as related to public safety and crime, include:
- (a) Types and characteristics of adjacent or nearby uses;
 - (b) Determine whether the development is intended to serve as a buffer, barrier or transitional use between different existing buildings/uses. Design features and configurations can optimize compatibility with those uses;
 - (c) Determine who are the intended users of the development and how the site can be designed to encourage desirable use while discouraging illegitimate activities;

- (d) The internal activities of the building should relate to one another and to external activities. Consideration should be given to how the building design elements influence the activities;
- (e) Consider the location of off-site pedestrian/bicycle and vehicular circulation systems in relation to the development, and how can the proposed structure would best relate to the circulation areas;
- (f) The on-site circulation areas (entrances, exits, loading area, refuse collection/service zones, parking lots, plazas, paseos, sidewalks, etc.) should provide safe environments while facilitating the intended use of the structure. Also, consider how the relationship between the building(s) and the circulation system elements can be enhanced to promote safety;
- (g) Window placement, lighting, parking areas, signs, landscaping, waiting areas, plazas, sidewalk-oriented uses, etc. should be designed to maximize natural surveillance;
- (h) Design treatments should be introduced to make certain features less susceptible to criminal activity or less likely to permit illegitimate activity (e.g. doors, windows, alleys, loading areas, refuse enclosures, fences, gates, etc.);
- (i) Landscaping should be incorporated and maintained to facilitate natural surveillance (i.e. sight lines and visual clearance areas); and
- (j) Investigate opportunities to use landscape materials to communicate territoriality and to incorporate plazas into the design of pedestrian linkages is highly encouraged.

11. Secretary of the Interior's Standards for Rehabilitation

- a. Every reasonable effort shall be made to provide a compatible use for a property which requires minimal alteration of the building, structure, or site and its environment or to use a property for its originally intended purpose.
- b. The distinguishing original qualities or character of a building, structure, or site and its environment shall not be destroyed. The removal or alteration of any historic material of distinctive architectural features should be avoided when possible.
- c. All buildings, structures, and sites shall be recognized as projects of their own time. Alterations which have no historical basis and which seek to create an earlier appearance shall be discouraged.
- d. Changes which may have occurred over the course of time are evidence of the history and development of a building, structure, or site and its environment. These changes may have acquired significance in their own right, and this significance shall be recognized and respected.
- e. Distinctive stylistic features or examples of skilled craftsmanship which characterize a building, structure, or site shall be treated with sensitivity.
- f. Deteriorated architectural features shall be repaired rather than replaced, wherever possible. In the event replacement is necessary, the new materials should match the material being replaced in composition, design, color, texture, and other visual qualities. Repair or replacement of missing architectural features should be based on accurate duplications of features substantiated by historic, physical, or pictorial evidence rather than on conjectural designs or the availability of different architectural elements from other buildings or structures.

- g. The surface cleaning of structures shall be undertaken with the gentlest means possible. Sandblasting and other cleaning methods that will damage the historic building materials shall not be undertaken.
- h. Every reasonable effort shall be made to protect and preserve archaeological resources affected by, or adjacent to, any project.
- i. Contemporary design for alterations and additions to existing properties shall not be discouraged when such alterations and additions do not destroy significant historical, architectural, or cultural material, and character of the property, neighborhood, or environment.
- j. Whenever possible, new additions or alterations to structures shall be done in such a manner that if such additions or alterations were to be removed in the future, the essential form and integrity of the structure would be unimpaired.

B. Airport

Text for this section will be developed upon completion of the Airport Master Plan.

VII. GLOSSARY

Awnings – A roof-like structure, generally of canvas or metal material, that is stretched and/or supported by a metal or wood frame.

Commercial Centers – Shopping facilities located throughout the City which provide goods and services to patrons. These range from single facilities such as “mom and pop” grocery stores to large regional shopping centers.

Fencing, Open – Fencing design which results in a physical barrier but does not completely obscure visibility. Open fences containing regular breaks which produce a “see-through” effect, either within or between sections of the fence.

Fencing, Closed – A fence which produces a physical and visual barrier, typically used to provide security between properties.

Multi-disciplinary design team – A group of individuals with professional expertise in the creation of built environments, including but not limited to those schooled in the fields of architecture, landscape architecture, art, engineering, environmental protection, management, and urban design.

Nonconforming lot – Parcels of land which lawfully existed as lots on the effective date of the City’s Zoning Ordinance but which do not conform to the current lot area and/or lot dimension standards for the zone in which they are located.

Old Town – The area in the general vicinity of H Street and Ocean Avenue identified on the City Zoning Map as the Downtown Overlay District.

Street furniture- Benches, planters, trash receptacles, light fixtures, newspaper racks, etc., placed in the public right-of-way for the use of the community.

Temporary building or structures – Miscellaneous structures set without foundations, such as sheds, canopies, or fences used for the protection of the public.

Water Features- Decorative elements for outdoor areas including but not limited to fountains, reflecting pools, fish ponds, and manmade streams.

VIII. Bibliography

Development and other projects subject to architectural review must also comply with the other applicable local, state, and federal laws. Some of these are referenced below for your convenience. Copies of the Lompoc City Code Sections are available from the City Clerk at a cost of ten cents per page.

Antenna, LCC § 17.096

Building Code, LCC §§ 15.01.101-15.48.010 and Uniform Building Code

Building Conservation, LCC § 15.16.020

Business Park District Development Standards, LCC § 17.065.050

Central Business District Development Standards, LCC § 17.044.040

Environmental Review, California Public Resources Code §§ 21000-21178.1 and CEQA Guidelines 15000-15387 with Appendices A-K

Fences and Walls, LCC § 17.088.150

Fire Safety Requirements and Uniform Fire Code

Landscaping Development, LCC § 17.092

Parking and Parking Lots, LCC § 17.112

Planned Commercial Development District Standards, LCC § 17.048

Planned Development District Standards, LCC § 17.032

Residential Zone Development Standards

 Single Family (R-1), LCC § 17.020

 Medium Density (R-2), LCC § 17.024

 High Density (R-3), LCC § 17.028

Satellite Dishes, LCC § 17.096

Signs, LCC § 17.018

Streets and Street Improvements, LCC §§ 12.12.010-12.28.080

Subdivision, California Government Code §§ 66410-66499.58 and LCC §§ 16.01-16.44.080

Swimming Pools, LCC § 17.088.140

Trees, LCC §§ 12.32.010-12.32.110

IX. Ordinance

ORDINANCE NO. 1405 (95)

AN ORDINANCE OF THE CITY OF LOMPOC AMENDING ARTICLE 1 OF CHAPTER 2 OF TITLE 3 OF CHAPTER 50 OF THE LOMPOC CITY CODE PERTAINING TO ARCHITECTURAL REVIEW

THE CITY COUNCIL OF THE CITY OF LOMPOC DOES HEREBY ORDAIN AS FOLLOWS:

SECTION 1. Article 1 of Chapter 2 of Title 3 of Chapter 50 of the Lompoc City Code is hereby amended to read as follows:

Title 3.

Chapter 2.

Article 1. Architectural Review.

Section 8825. Purpose.

The purpose of Architectural Review is to determine compliance with provisions of the technical codes and development policies of the City and consistency with the established Architectural Review Guidelines. Additionally, architectural review is intended to promote an aesthetically and environmentally pleasing and economically viable community.

Section 8826. Architectural Review Required.

- A. All applications for permits for the construction of any building, structure, or sign in all zoning districts, with the following exception, shall be reviewed for consistency with the architectural guidelines. This Article does not apply to single family homes in R-1 Districts which are not part of a parcel map or subdivision map.
- B. All applications for architectural review shall be made on the forms specified and accompanied by the information required by the application. The application shall include building elevations, site and landscaping plans, renderings of signs, and other information necessary to determine consistency with the architectural guidelines.

Section 8826.1 Project Approval.

- A. Except as provided in subsections B and C of this Section, the required review shall be conducted by the City Planner and shall include the recommendations of other City Divisions and Departments, as necessary, resulting in a project which is approved, conditionally approved, or disapproved.
- B. The Planning Commission shall perform the required review and render a decision concerning the architectural review function:
 - 1. on all major projects which are located on parcels or lots with frontage on Ocean Avenue, Central Avenue, and "H" Street north of Cypress Avenue;
 - 2. on major commercial and industrial projects on "A" Street north of Cypress Avenue; and
 - 3. on all projects involving the designated landmarks and historical structures and places referred to in the 1988 City of Lompoc Cultural Resources Study, a copy of *which* is on file in the Office of the City Clerk.
- B. The City Planner may refer, with or without recommendation, any application for architectural review directly to the Planning Commission for decision.

Section 8827. Processing Time.

All applications properly received and determined to be complete for processing in accordance with California Government Code Sections 65940 et seq. shall be reviewed within the following time periods:

- A. Projects which are acted upon by the City Planner shall be approved, conditionally approved, or disapproved within ten (10) working days of the date of receipt of a complete application.
- B. Projects which are acted upon by the Planning Commission shall be approved, conditionally approved, or disapproved within thirty (30) working days of the date of receipt of a complete application and after consideration by the Planning Commission during a regularly scheduled meeting.

Section 8828. Adoption of Architectural Review Guidelines.

- A. The Council specifically finds and determines that the Lompoc Valley's natural beauty and history render the aesthetic quality of the City an important economic asset, and City design standards and other City rules, regulations, and standards relating to aesthetics and overall appearance of property are designed to protect that asset and conserve property values within the City.
- B. The City Council declares and adopts the following policies relating to all development and design within the City:

- 1. Protection of the quality of life of the residents of Lompoc by use of designs that preserve and enhance privacy and minimize detrimental conditions such as noise, glare, unattractive uses, and unsightly elements is required for all projects.

- 2. Development of residential neighborhoods to preserve unity of character, unique features, and natural conditions to advance toward the goal of neighborhoods harmonious with others and of new residences compatible with existing homes and with the neighborhood is required for all projects subject to this Article.

- 3. Protection and preservation of the following are encouraged on all projects to the extent feasible:

Protection and preservation of the following are encouraged on all projects to the extent feasible:

- a. views;
 - b. open space;
 - c. historically significant sites and structures; and
 - d. privately owned public art on private property.

C. The adoption of this Ordinance is specifically intended also to adopt the "Architectural Review Guidelines" (April 1995 Edition) relating to all design and development within the City of Lompoc. A copy of the "Architectural Review Guidelines" is on file in the Office of the City Clerk.

D. In determining whether to approve, conditionally approve, or disapprove architectural plans, drawings, or sketches, the Planning Commission, City Planner, and Community Services Department staff shall follow and carry out the architectural and landscaping guidelines adopted by the City Council.

E. It shall be unlawful for any person to carry out any project subject to this Article without compliance with all applicable landscape and design standards, project conditions of approval, and all laws and regulations applicable thereto.

Section 8829. Appeal to Planning Commission.

If the applicant or any interested person is aggrieved by the decision of the City Planner, an appeal in writing, together with the appropriate appeal fee as set by City Council Resolution, shall be submitted to the Planning Commission within ten (10) days following the date of decision by the City Planner. The Planning Commission, within thirty (30) days following the filing of an appeal, shall affirm, modify, or reverse the decision of the City Planner. Failure to act within the prescribed time shall be deemed to affirm the City Planner's decision.

Section 8830. Appeal to City Council.

If the applicant, any interested person, or the City Planner is aggrieved by the decision of the Planning Commission, an appeal in writing, together with the appropriate appeal fee as set by City Council Resolution, shall be submitted to the City Council within ten (10) days following the date of decision by the Planning Commission. Appeals shall be processed in accordance with Chapter 1, Sections 0133.C and 0133.D of the Lompoc City Code.

Section 8831, Approval as Prerequisite to Issuance of Permit.

No permit for the construction of any building or structure subject to this Article shall be issued until the architectural plans, drawings, or sketches have been approved by the City Planner, Planning Commission, or City Council. All buildings, structures, and grounds shall be developed in strict conformance with the approved architectural plans, drawings, or sketches. The City Planner may require the applicant to post sufficient security, in a form approved by the City Attorney, to insure the applicant's faithful performance of the approved project.

Section 8832. Revocation of Permit.

The Planning Commission may, after a public hearing with notice to the permittee, revoke any approval given pursuant to this Article, for noncompliance with any of the conditions imposed through the approval process. Such revocation shall constitute revocation of the permit. Written notice of intention to revoke shall be mailed to the permittee not less than thirty (30) days before the Planning Commission hearing date. Revocation may be appealed in the manner provided in Section 8830.

Section 8835. Lapse of Approval,

Architectural review approval is conditioned upon the rights or privileges acquired thereby being utilized within one year after the effective date of approval. Should the approved project not be so commenced and diligently pursued to completion, approval shall automatically lapse, except that if performance has been delayed by the City in approving plans, the City Planner shall grant and record a commensurate extension. The City Planner may, upon request of the permittee, for cause, grant a reasonable extension of time in addition to the one-year period. Requests for extension

shall be filed with the City Planner fifteen (15) days prior to expiration of architectural review approval."

SECTION 2. This Ordinance shall be effective thirty (30) days after its adoption.

PASSED AND ADOPTED this 19th day of September 1995, by the following electronic vote:

AYES:	Councilmember:	Mary Leach, Will Schuyler, Michael Siminski George Stillman, Mayor Joyce Howerton.
NOES:	Councilmember:	None.
ABSENT:	Councilmember:	None.
ABSTAINED:	Councilmember:	None.



Joyce Howerton, Mayor
City of Lompoc

ATTEST:

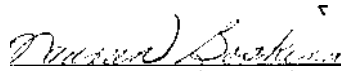

Maureen Bosking, City Clerk
City of Lompoc

CERTIFICATE OF ADOPTION

State of California
County of Santa Barbara) ss City of Lompoc

I, MAUREEN BOSKING, the duly appointed City Clerk of the City of Lompoc, California, do hereby certify that the foregoing Ordinance No. 1405(95) was introduced at a regular meeting of the City Council of the City of Lompoc, California, held on the 5th day of September, 19 95, and was at a regular meeting of said City Council, held on the 19th day of September 19 95, by the following vote, to-wit:

AYES:	Councilmember:	<u>Mary Leach, Will Schuyler, Michael Siminski</u>
		<u>George Stillman, Mayor Joyce Howerton.</u>
NOES:	Councilmember:	<u>None.</u>
ABSENT:	Councilmember:	<u>None.</u>
ABSTAINED:	Councilmember:	<u>None.</u>

That said Ordinance No. 1405(95) was then and there declared adopted and has been signed by the Mayor and attested by the Clerk of said City of Lompoc.

IN WITNESS WHEREOF, I have hereunto set my hand and affixed the official seal of the City of Lompoc, this 19th day of September, 19 95, at Lompoc, California.

I declare under penalty of perjury that the foregoing is true and correct.

S E A L

Maureen Bosking, CMC, City Clerk
City of Lompoc, California